



DIPUTACIÓN
DE ALICANTE

Área de Recursos Humanos

Unidad de Desarrollo Organizacional

ESTRUCTURAS ORGANIZATIVAS DE LA DIPUTACIÓN DE ALICANTE

Marzo 2016

IMAGEN Y PROMOCIÓN INSTITUCIONAL

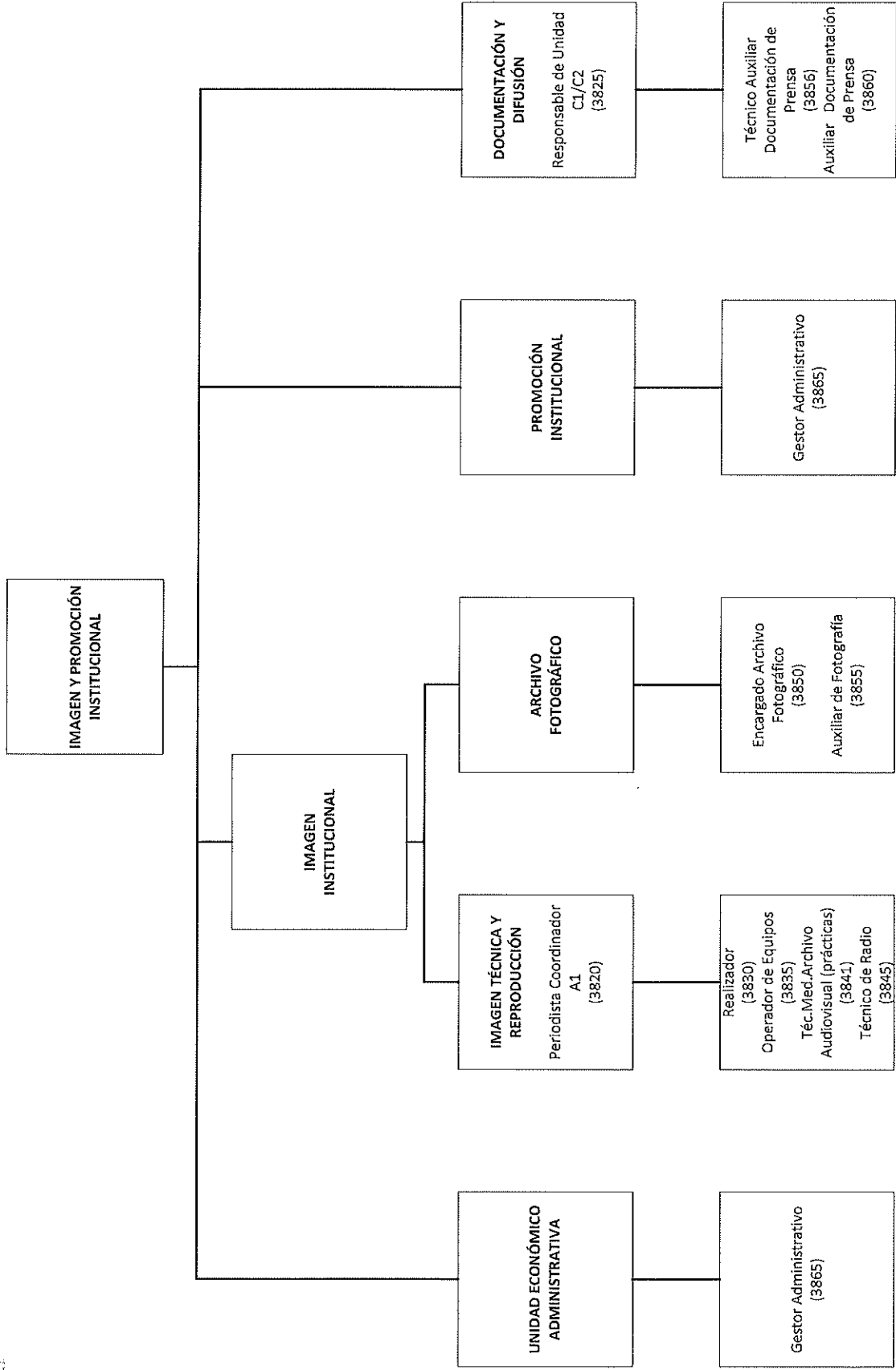

PRESIDENCIA

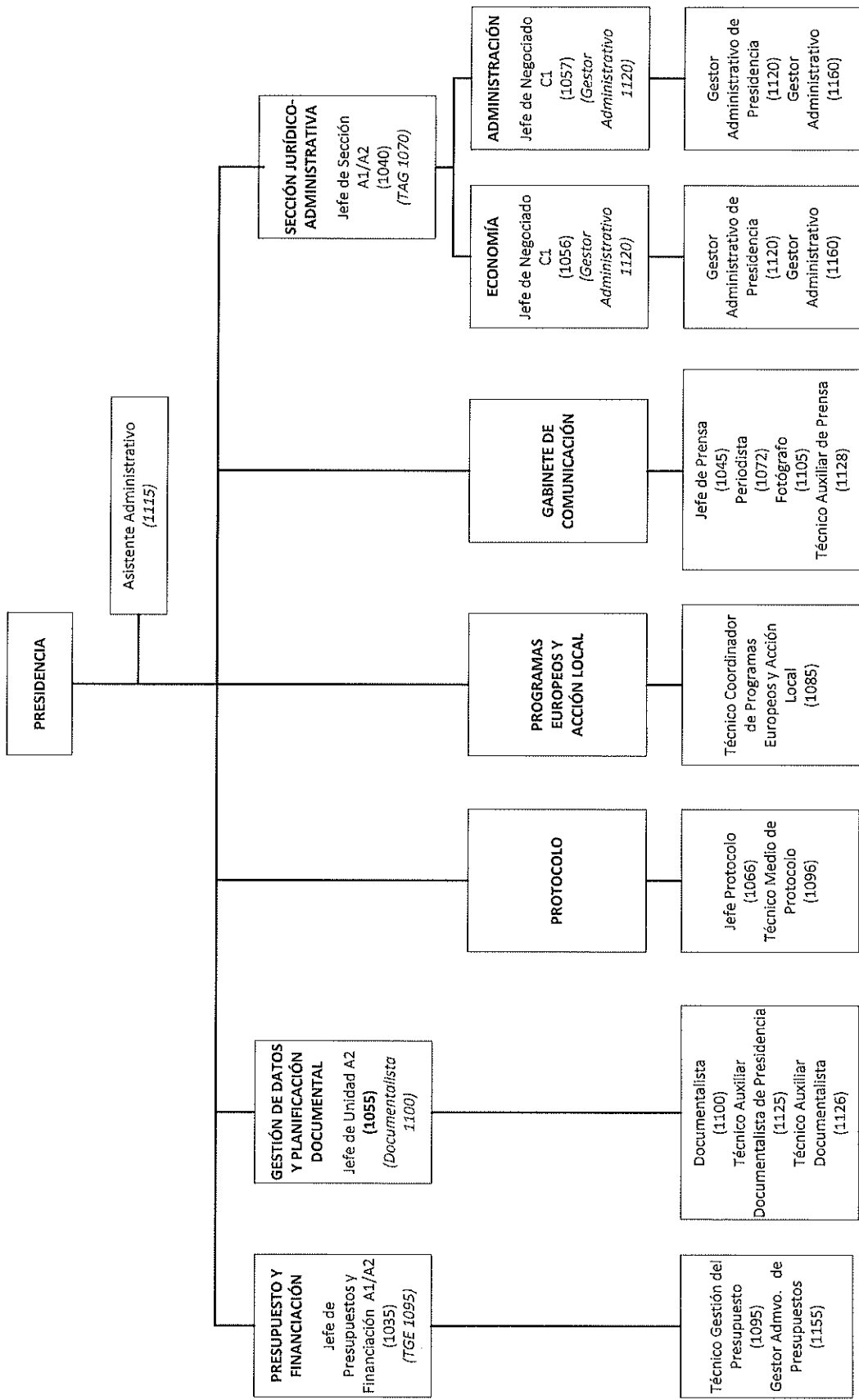

SECRETARÍA GENERAL

Organigrama de
Estructura
Organizativa

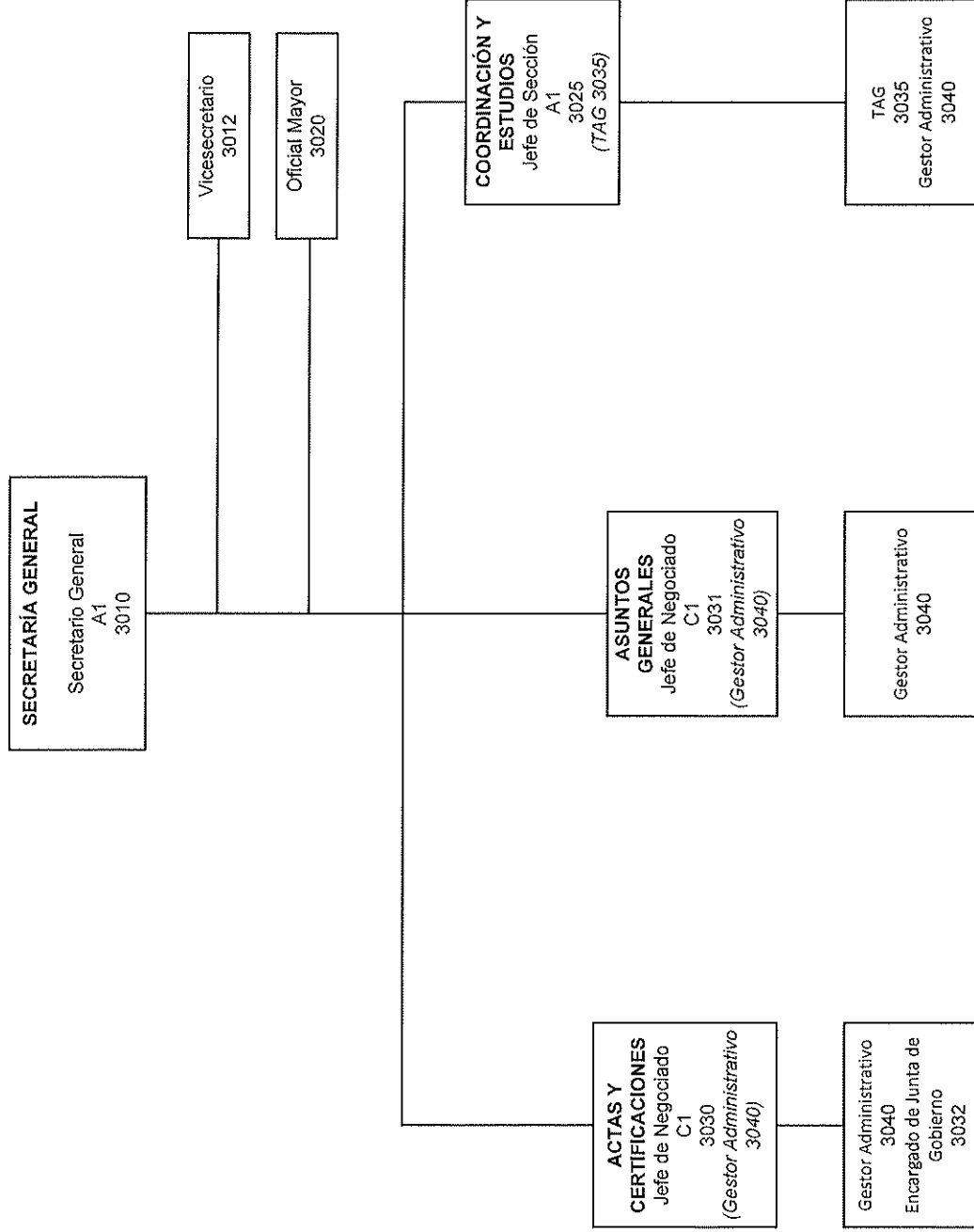



DIPUTACIÓN DE ALICANTE

INTERVENCIÓN

Organigrama de Estructura Organizativa

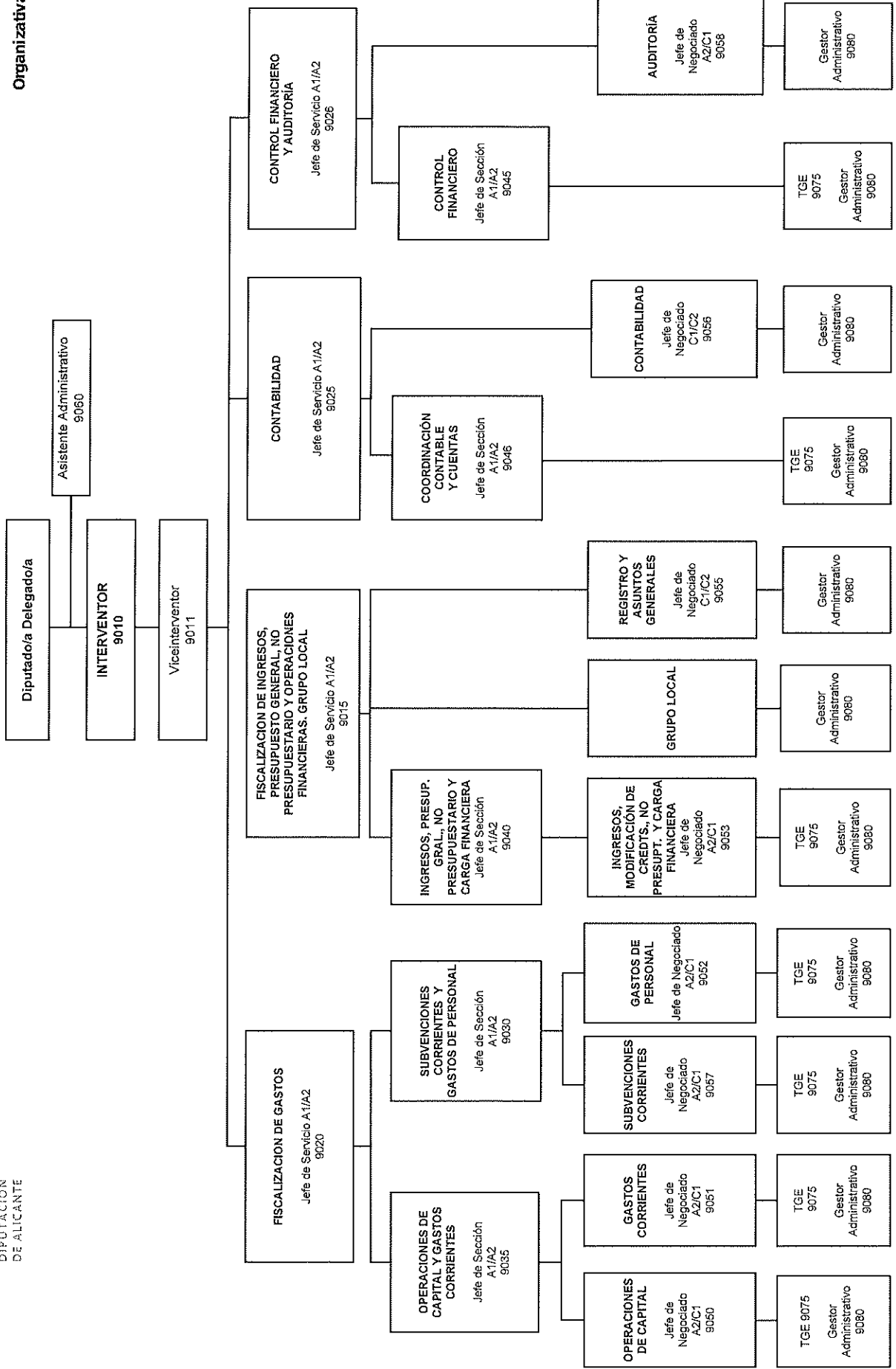

TESORERÍA

Organigrama de

 Estructura

 Organizativa

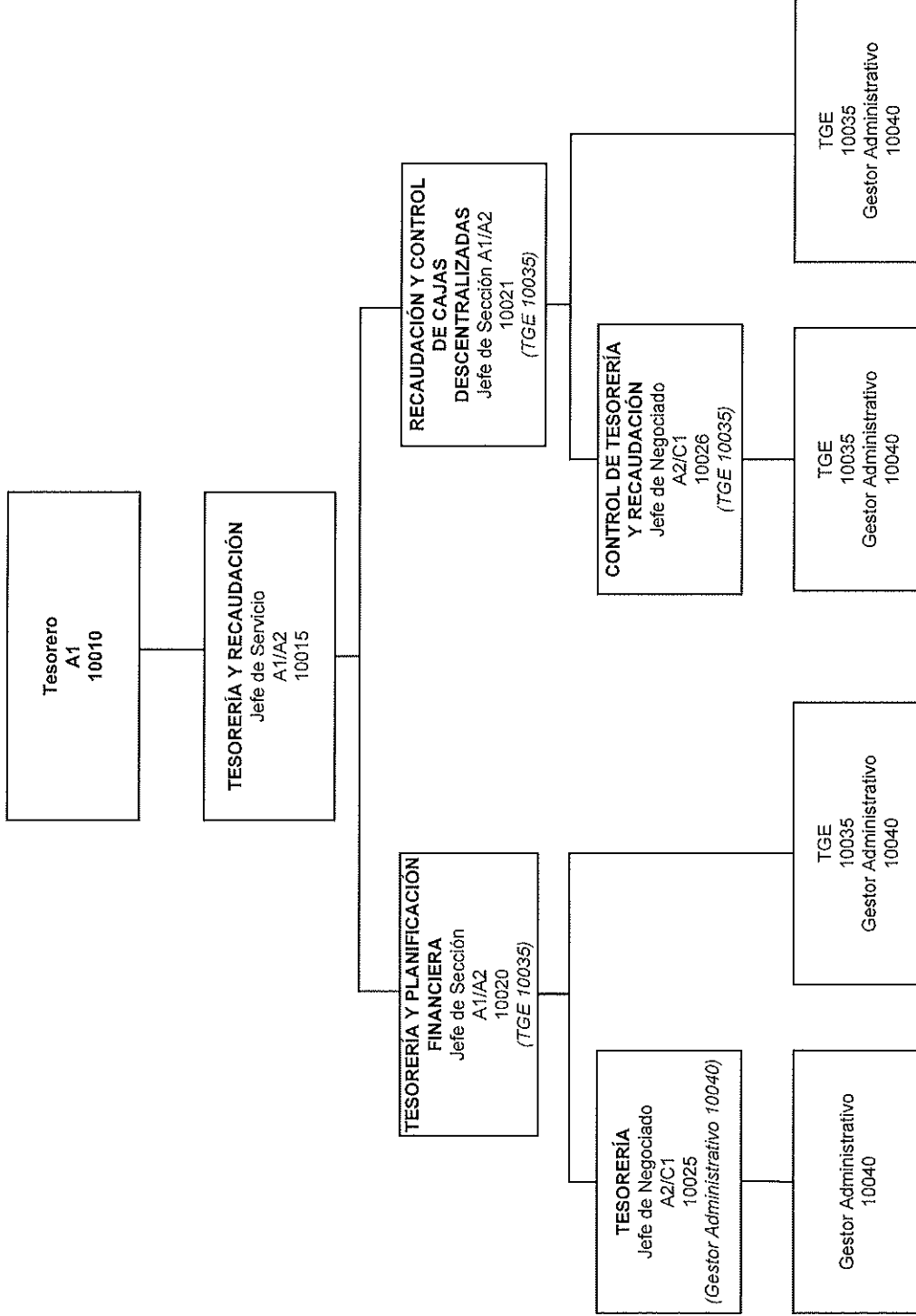

PATRIMONIO

Organigrama de
Estructura
Organizativa

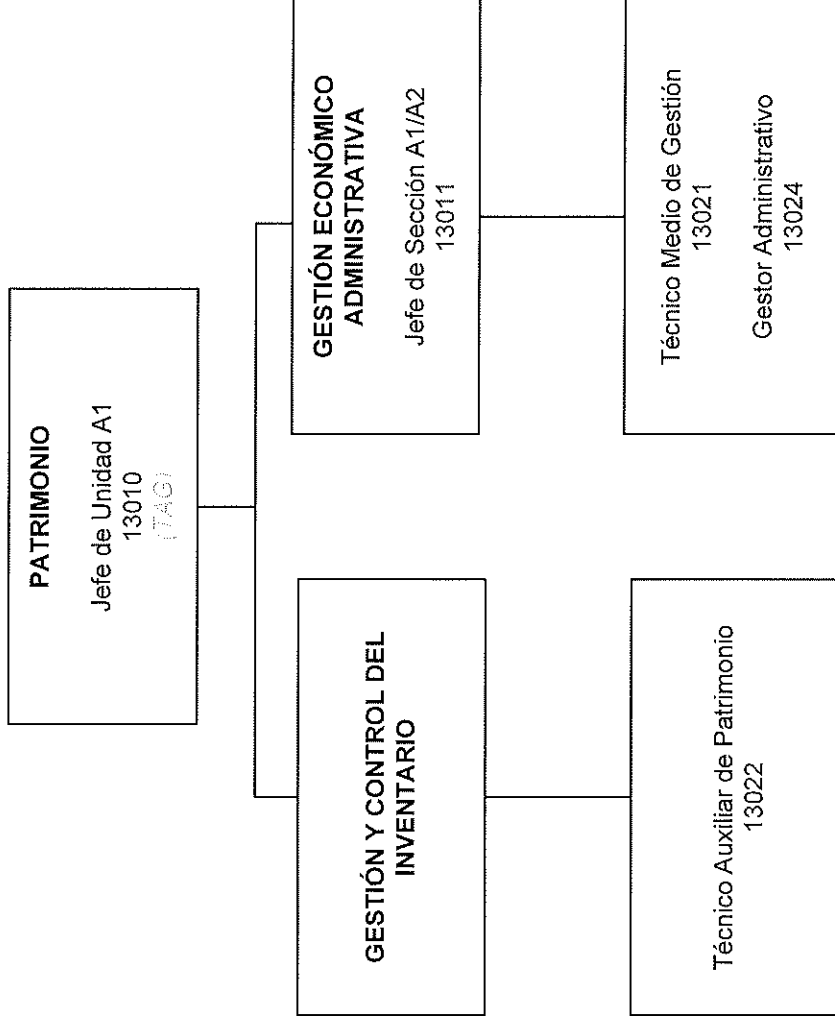



CONTRATACIÓN

Organigrama de
Estructura
Organizativa

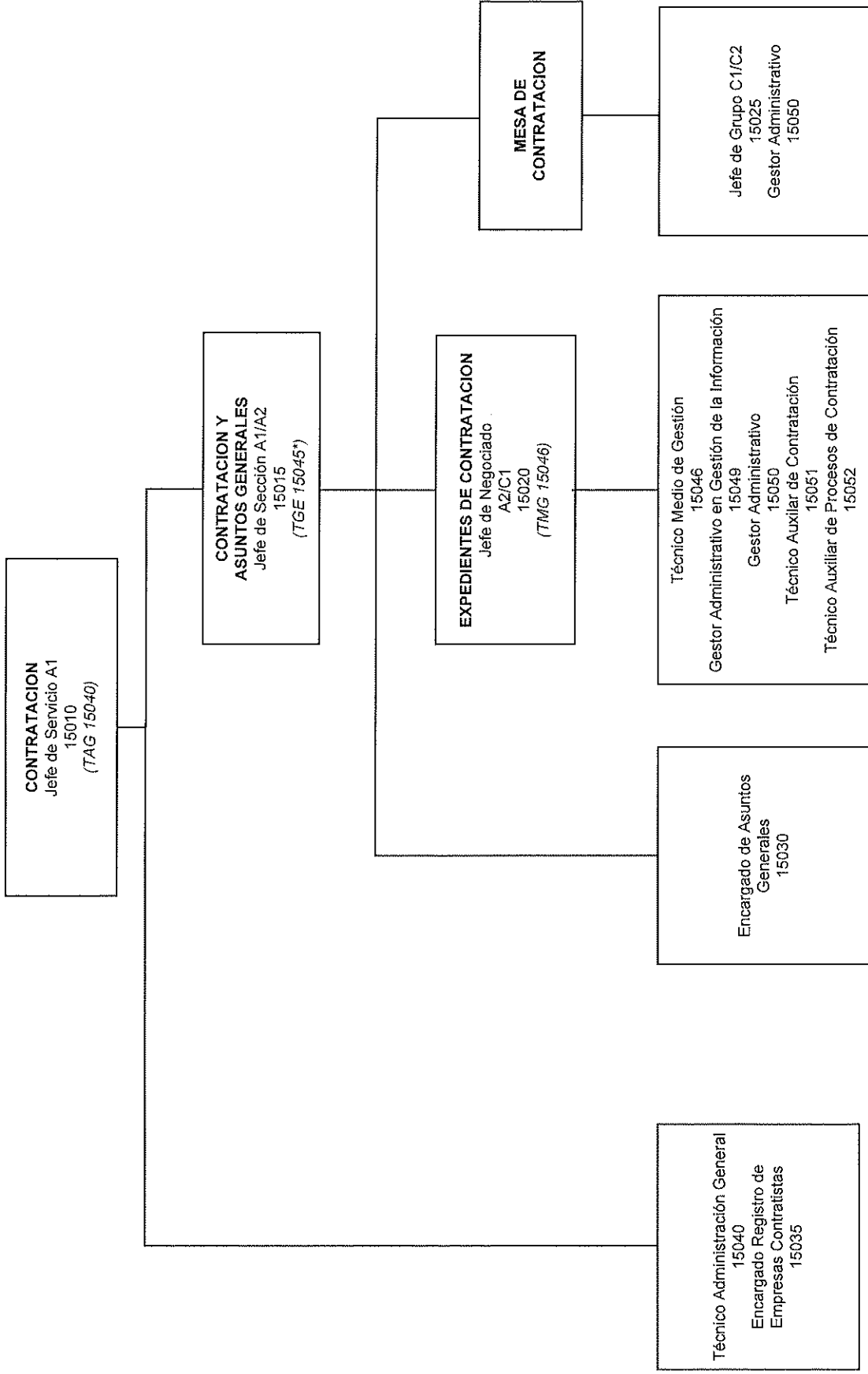



CONSERVACIÓN DE EDIFICIOS E INSTALACIONES

Organigrama de Estructura Organizativa

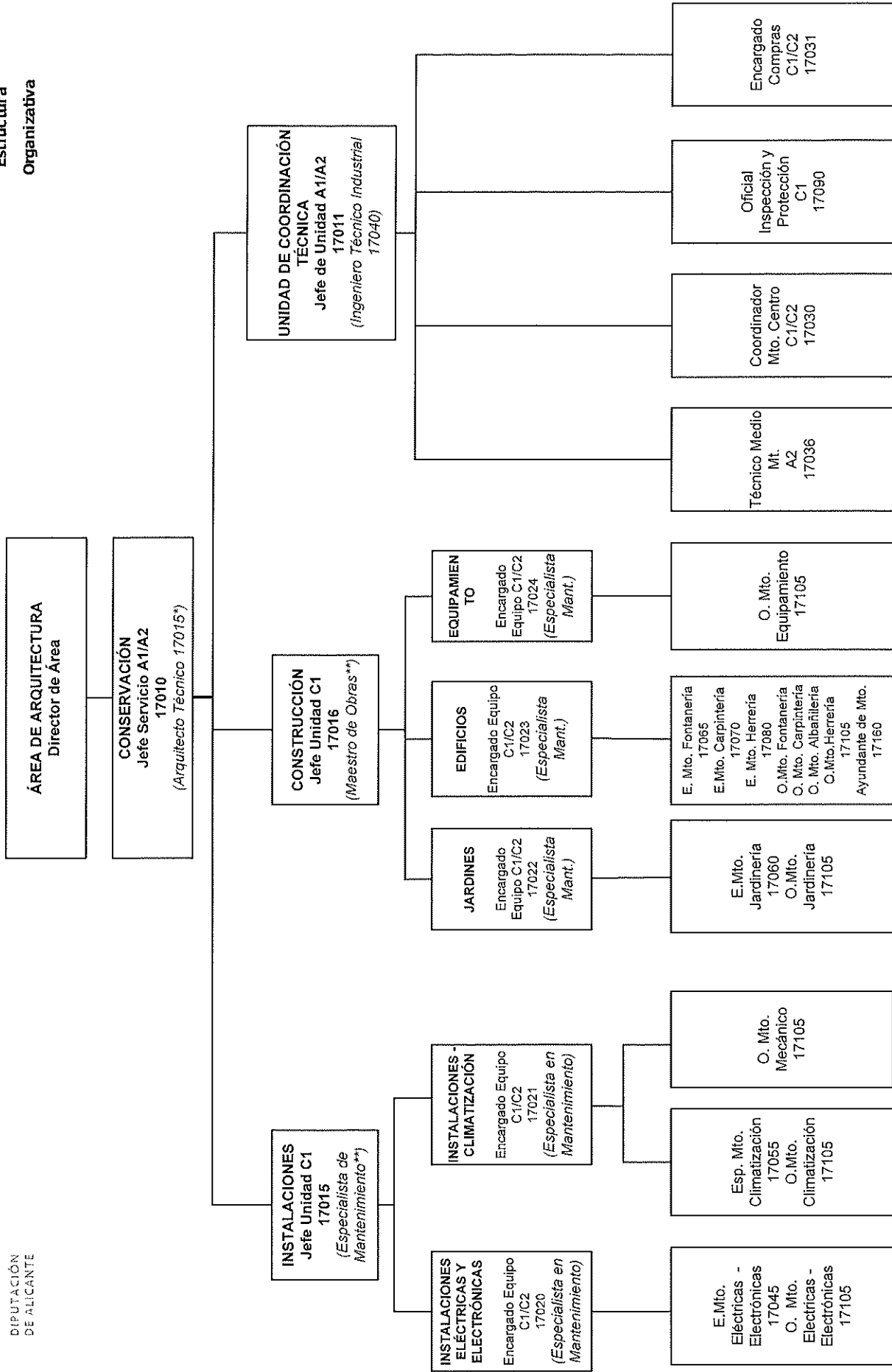

FORMACIÓN Y CALIDAD

- Área de Recursos Humanos -

ÁREA DE RECURSOS HUMANOS
Dirección de Área

**Organigrama de
Estructura
Organizativa**

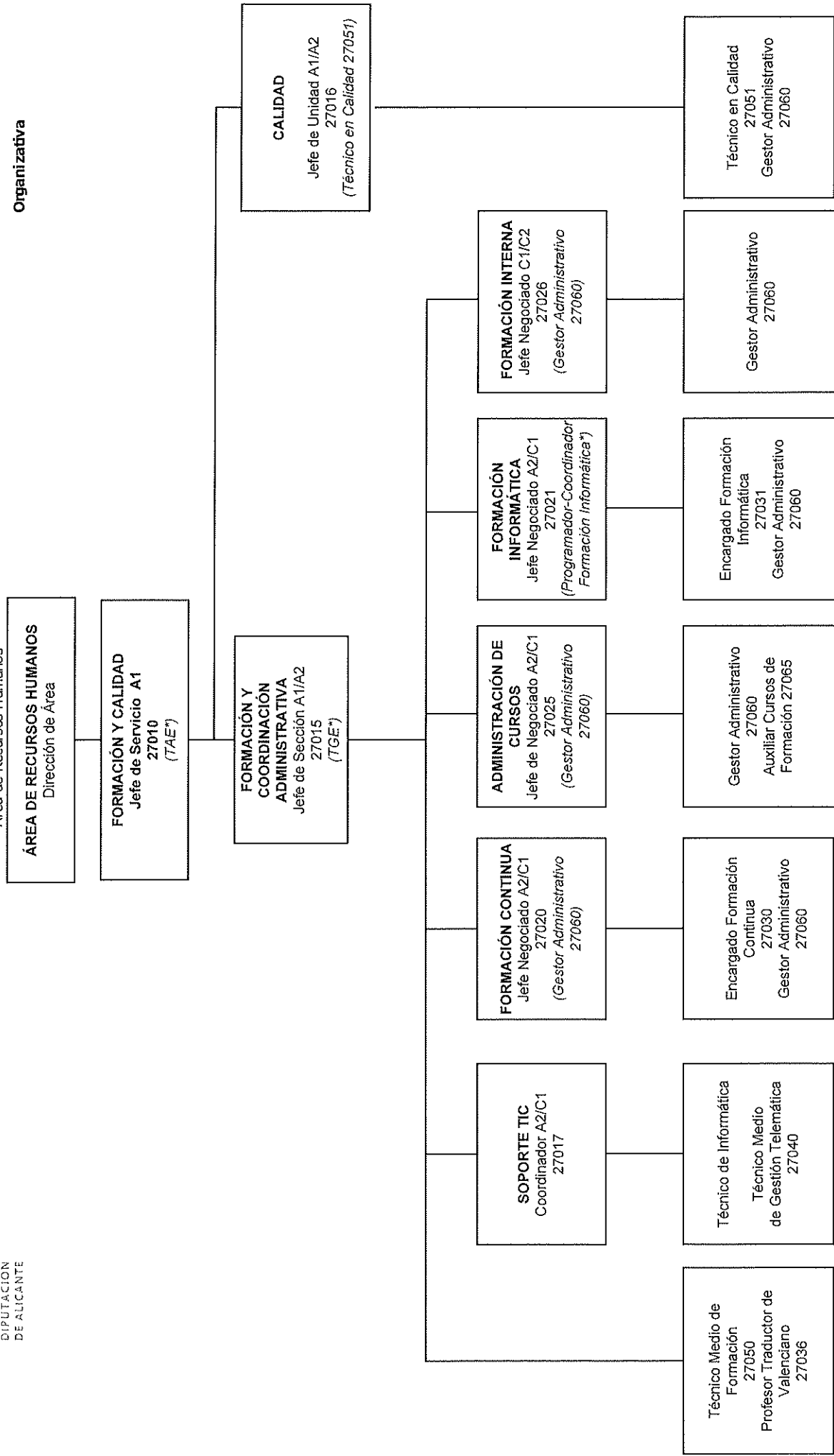



Organigrama de Estructura Organizativa

PERSONAL Y DO

- Área de Recursos Humanos -

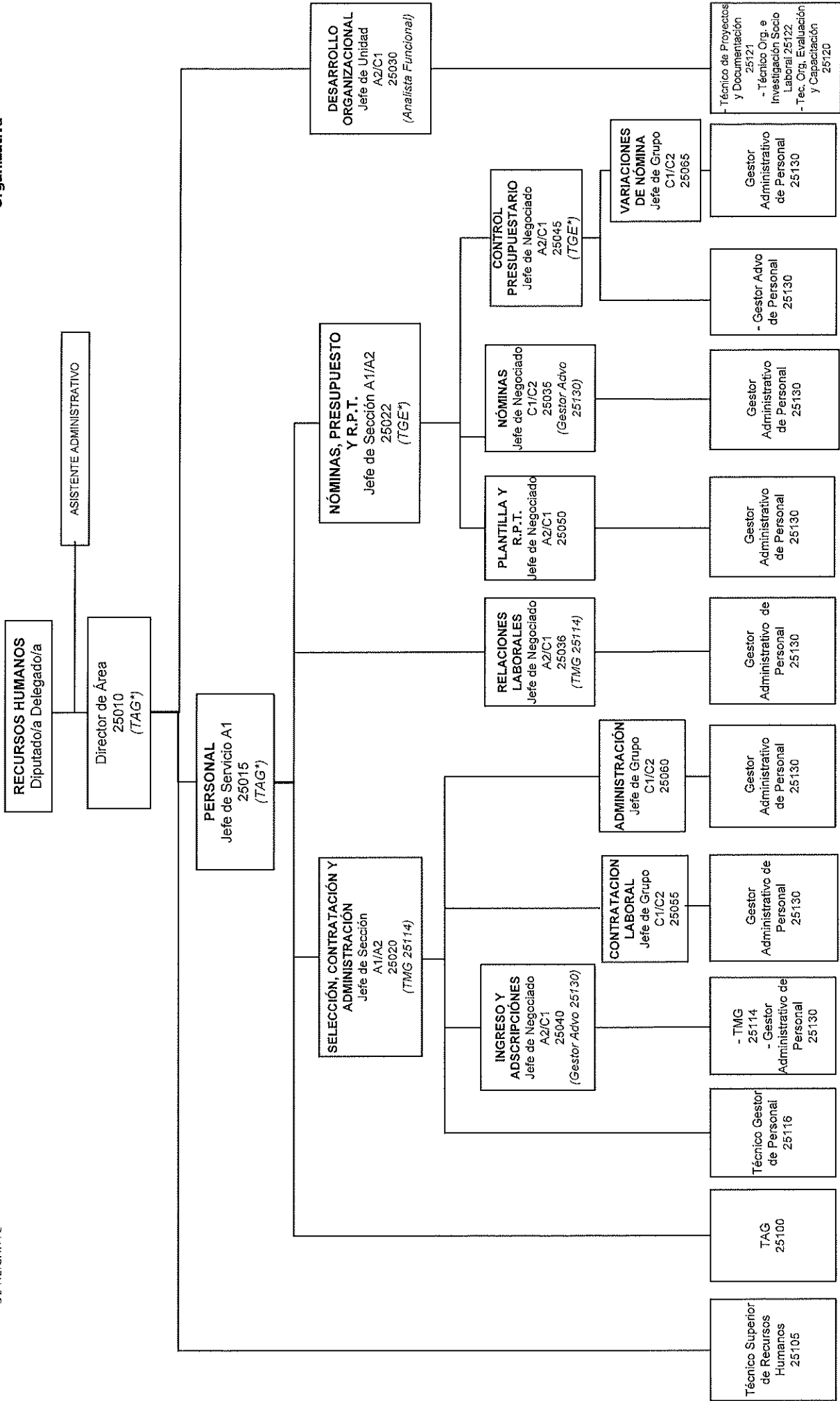

SERVICIO PREVENCIÓN RIESGOS LABORALES

- Área de Recursos Humanos -

Organigrama de
 Estructura
 Organizativa

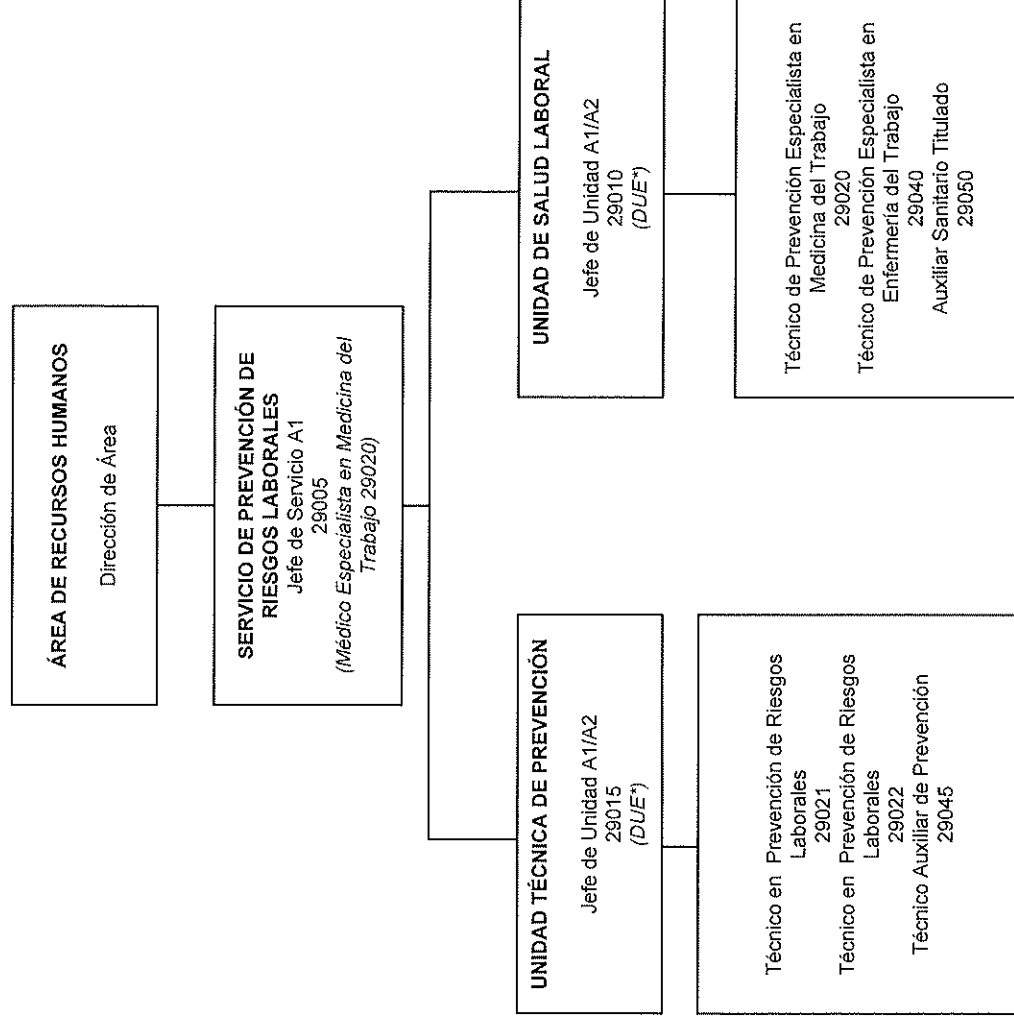



GESTIÓN DOCUMENTAL, REGISTRO E INFORMACIÓN

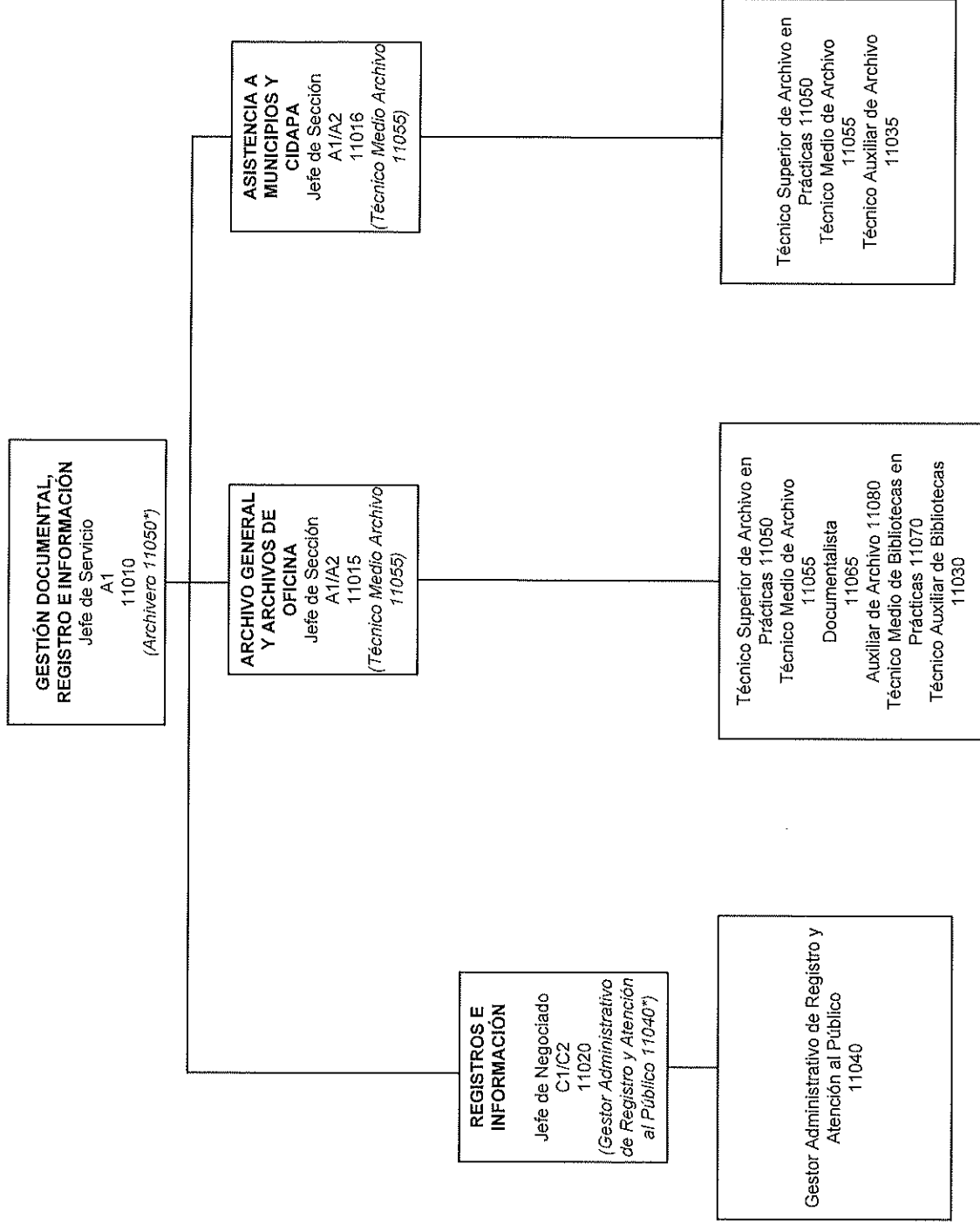



SERVICIOS JURÍDICOS

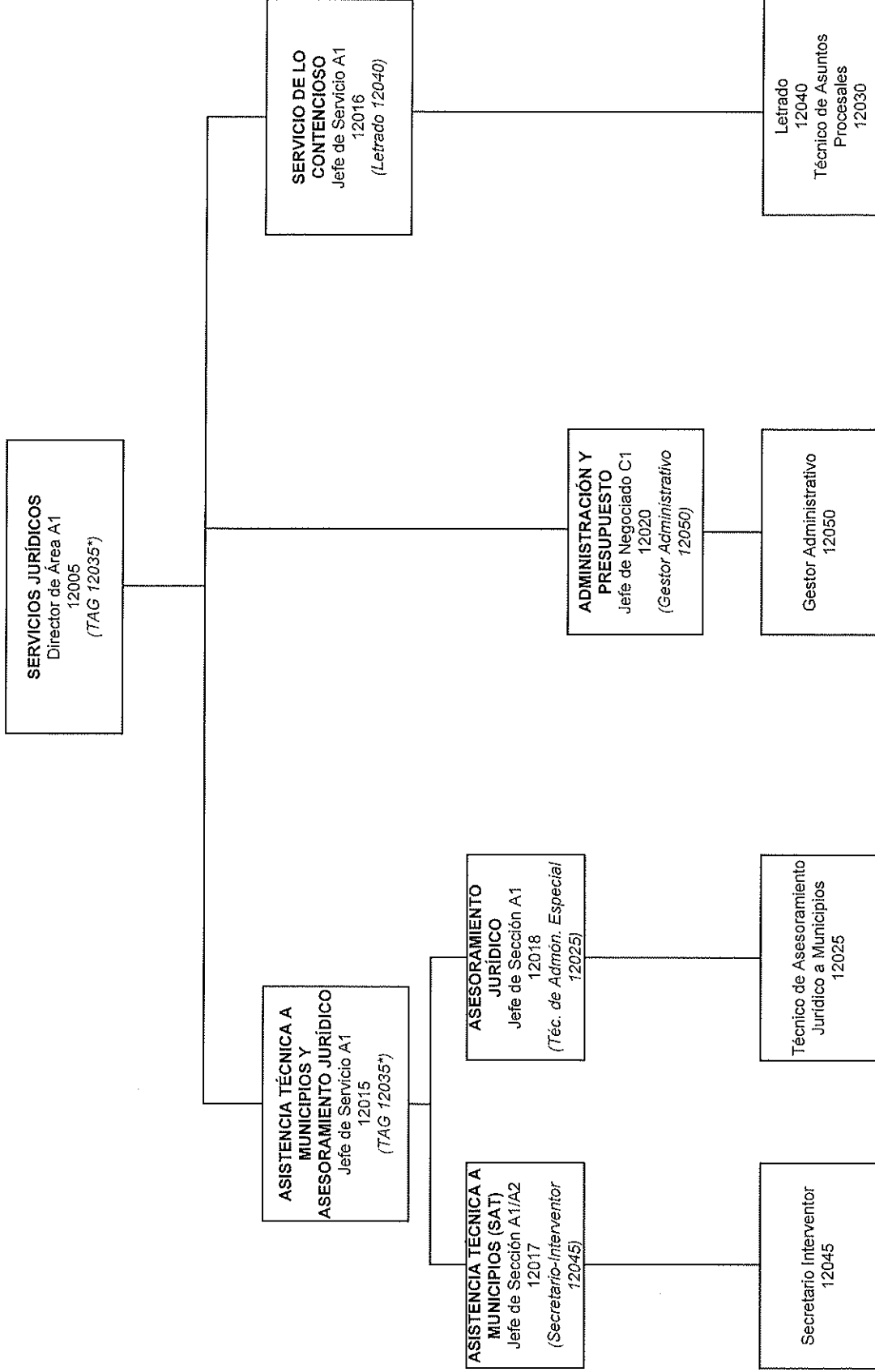

INFORMÁTICA

Organigrama de Estructura Organizativa

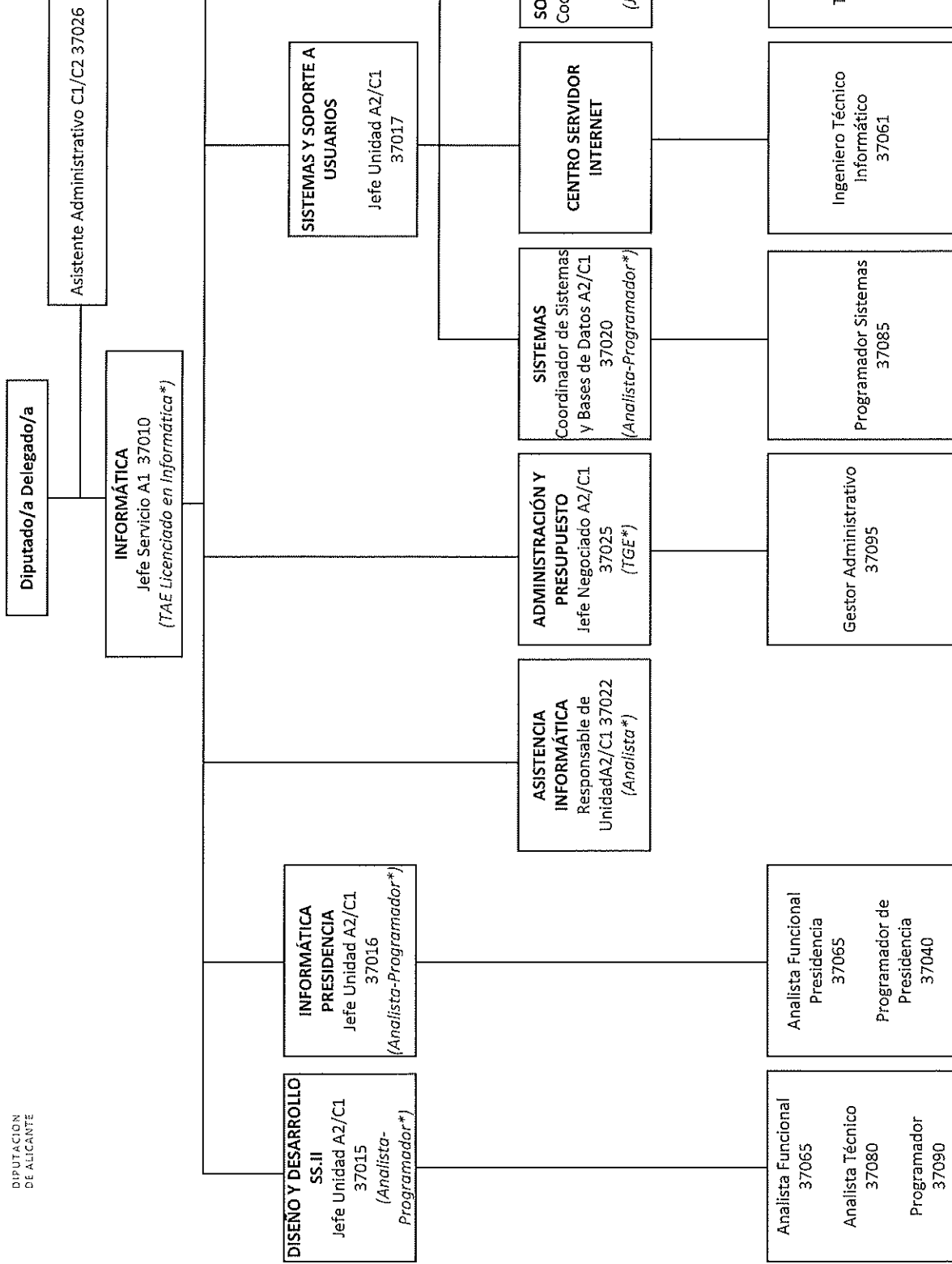

RÉGIMEN INTERIOR

Organigrama de
Estructura
Organizativa

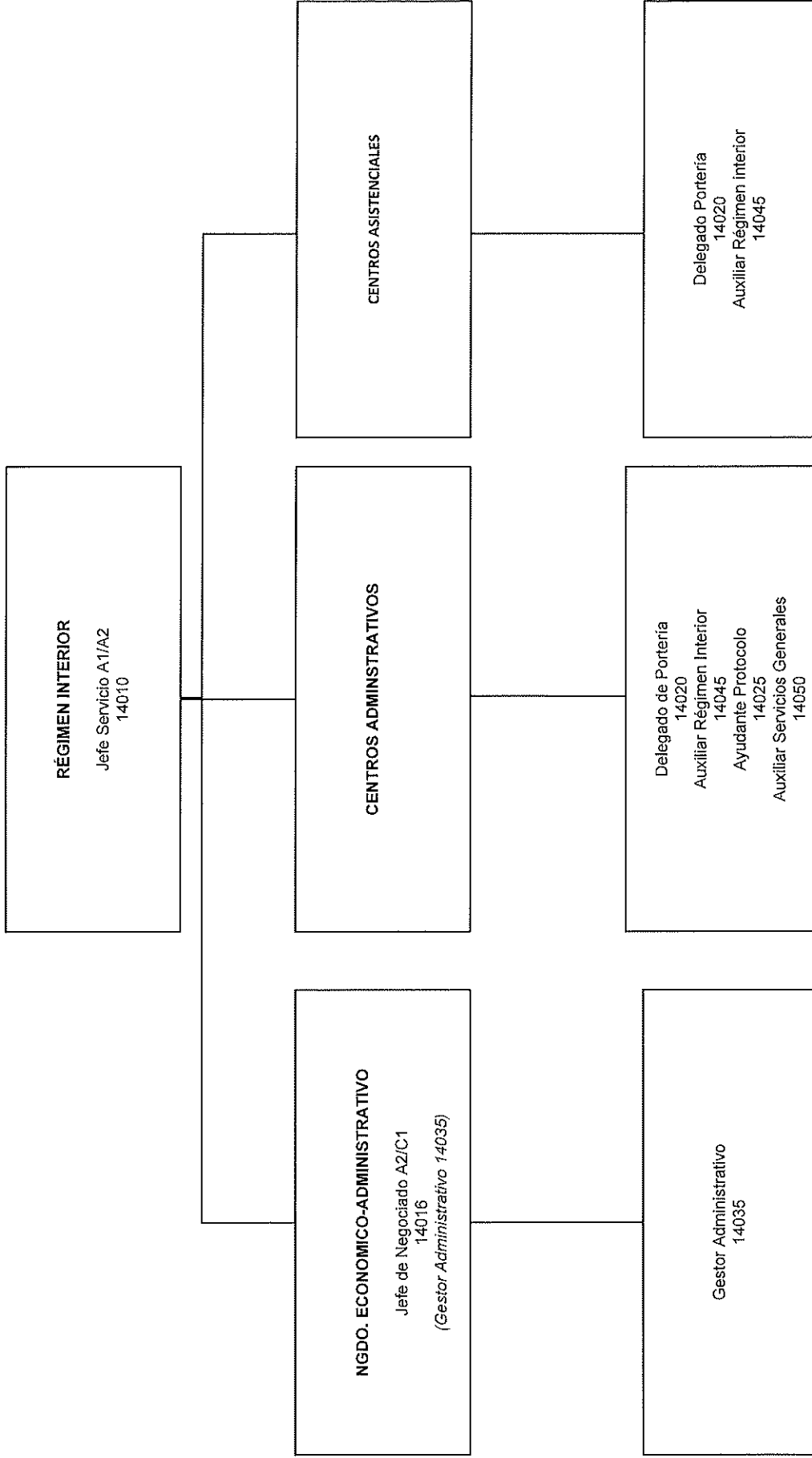

TELEFONÍA Y REDES DE COMUNICACIÓN

**Organigrama de
Estructura
Organizativa**

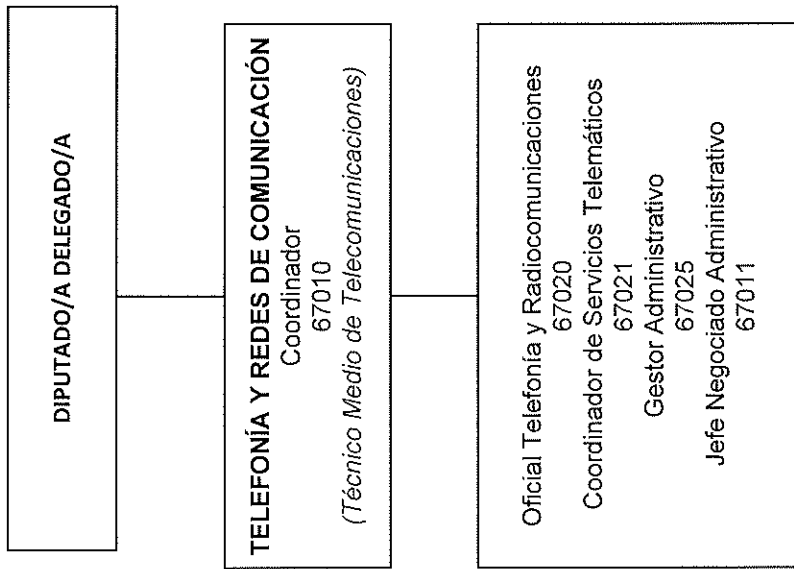

PARQUE MÓVIL Y TALLERES

Organigrama de
Estructura
Organizativa

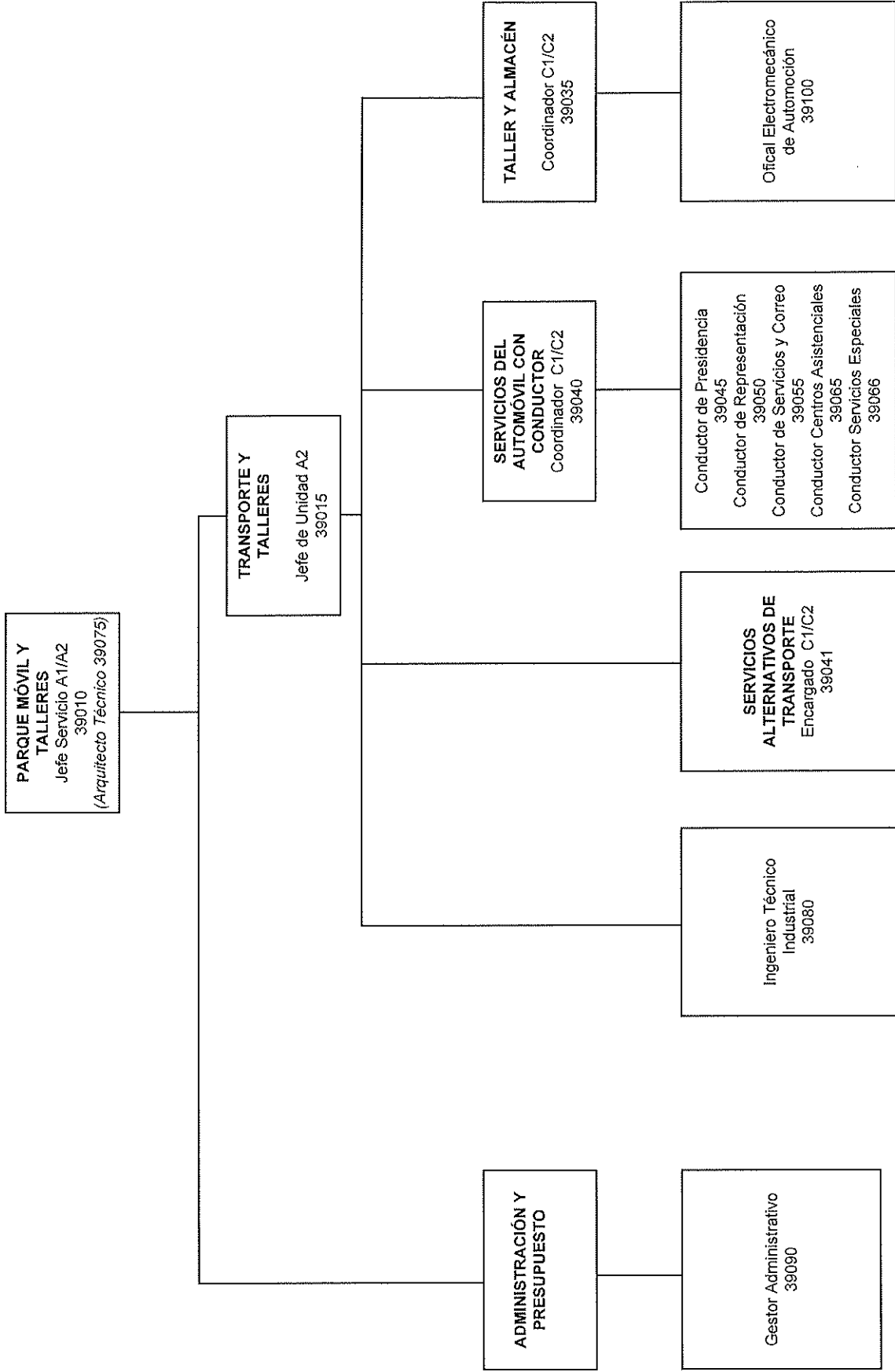



BOP E IMPRENTA

Organigrama de Estructura Organizativa

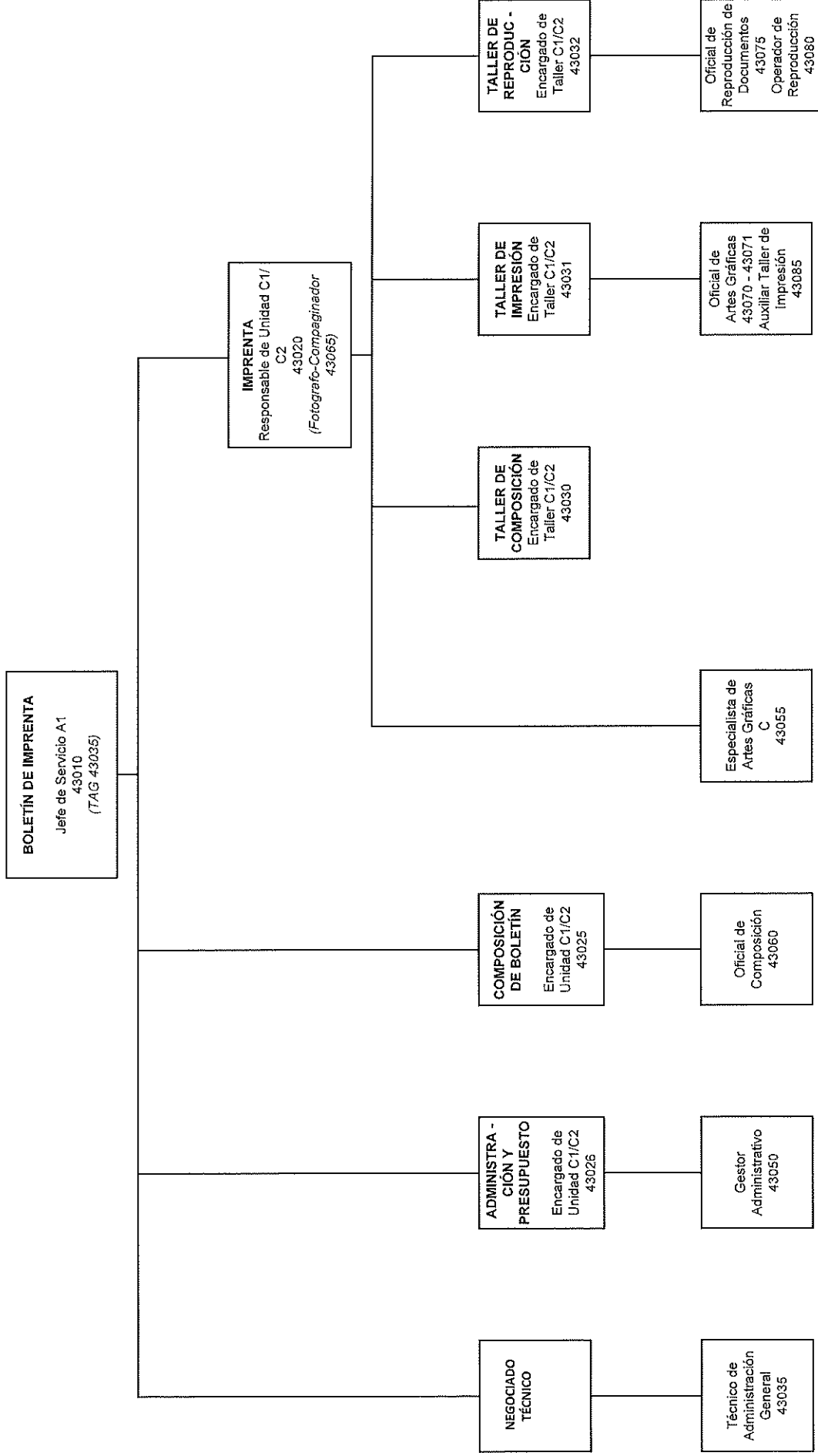

HOGAR PROVINCIAL

- Área de Hogar Provincial -

Organigrama de Estructura Organizativa

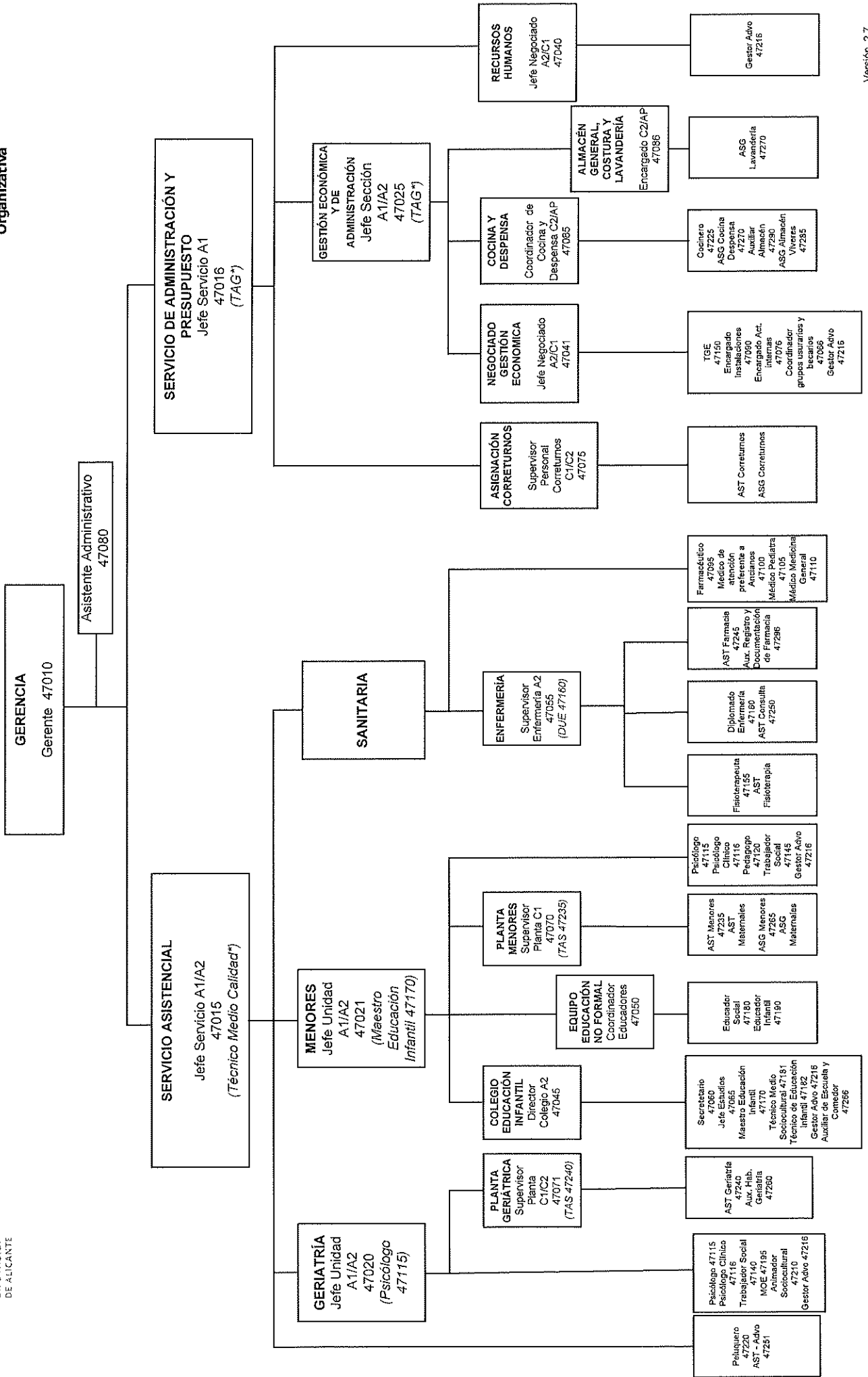

BIENESTAR SOCIAL

Organigrama de

 Estructura

 Organizativa

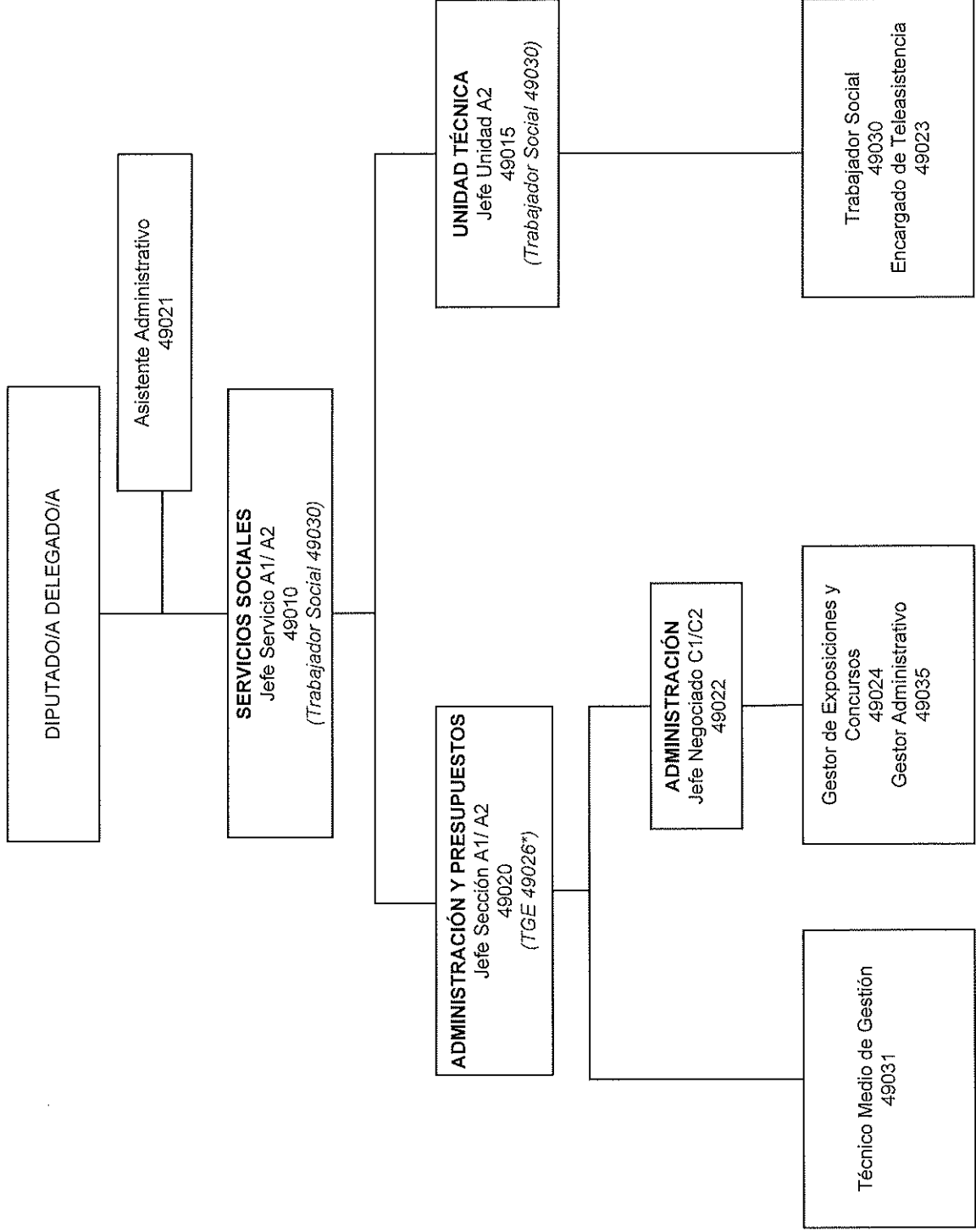

CULTURA

Organigrama de
Estructura
Organizativa

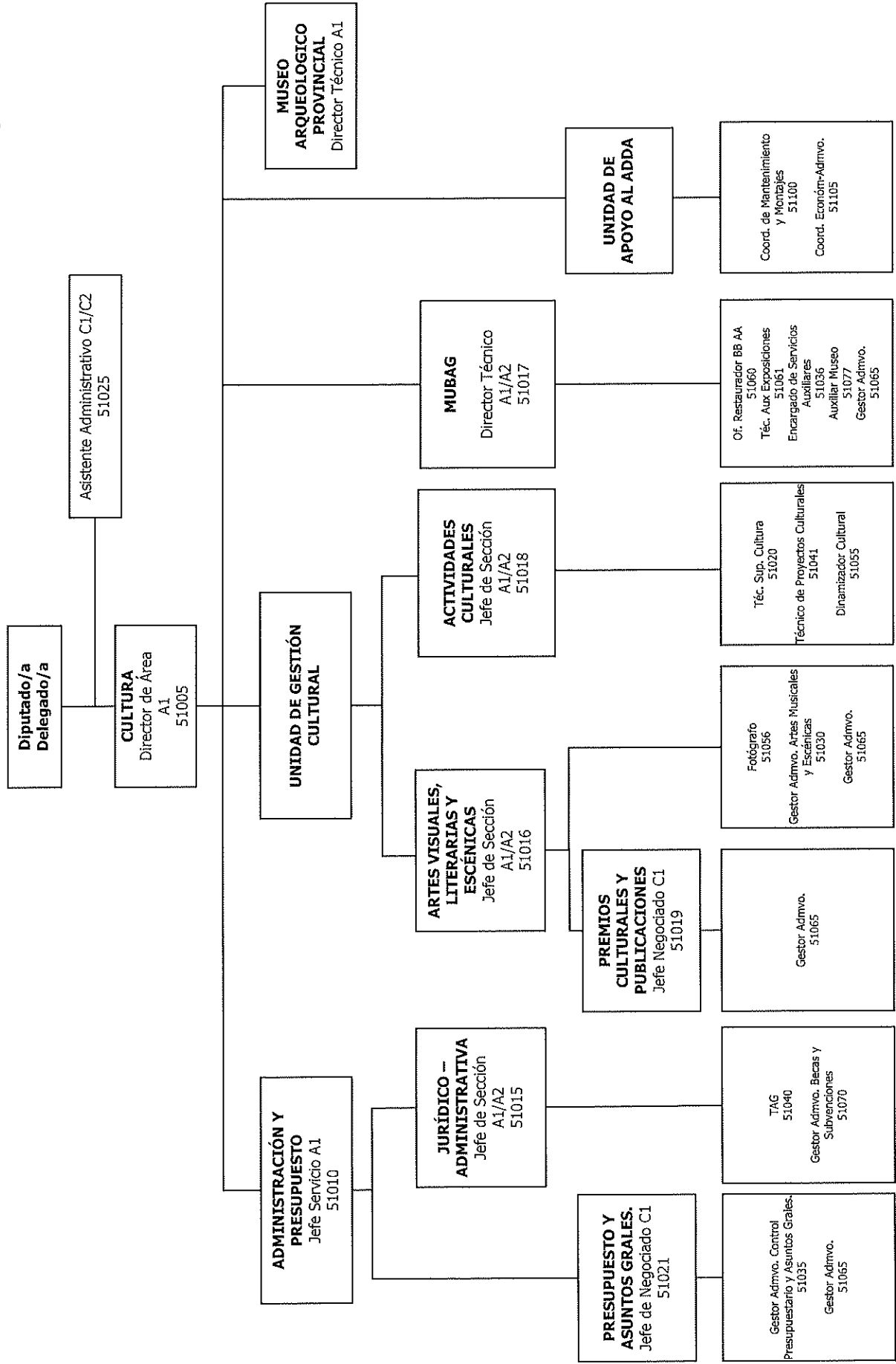

DEPORTES

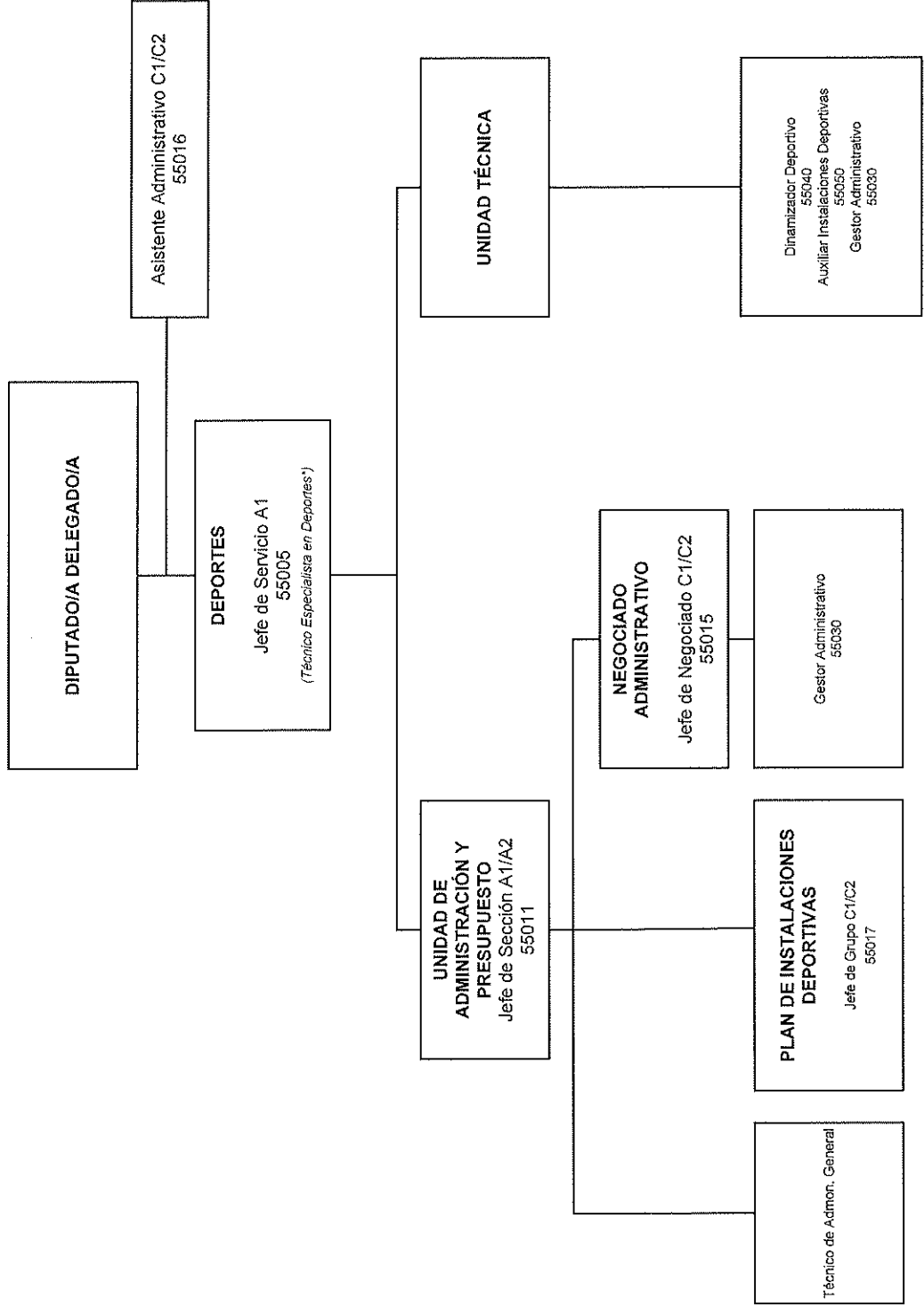

IGUALDAD Y JUVENTUD

Organigrama de
Estructura
Organizativa

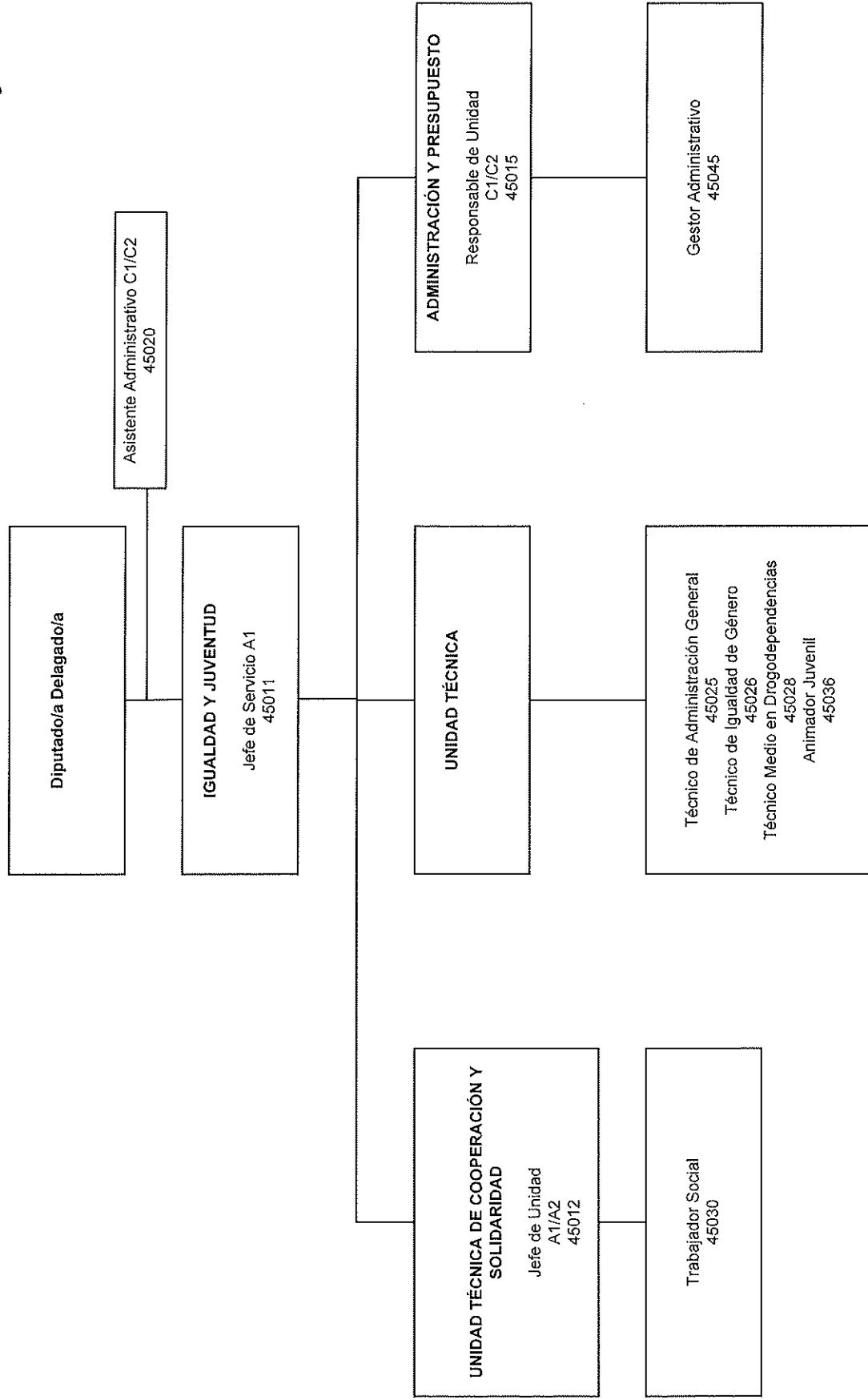

ÁREA DE COOPERACIÓN

**Organigrama de
Estructura
Organizativa**

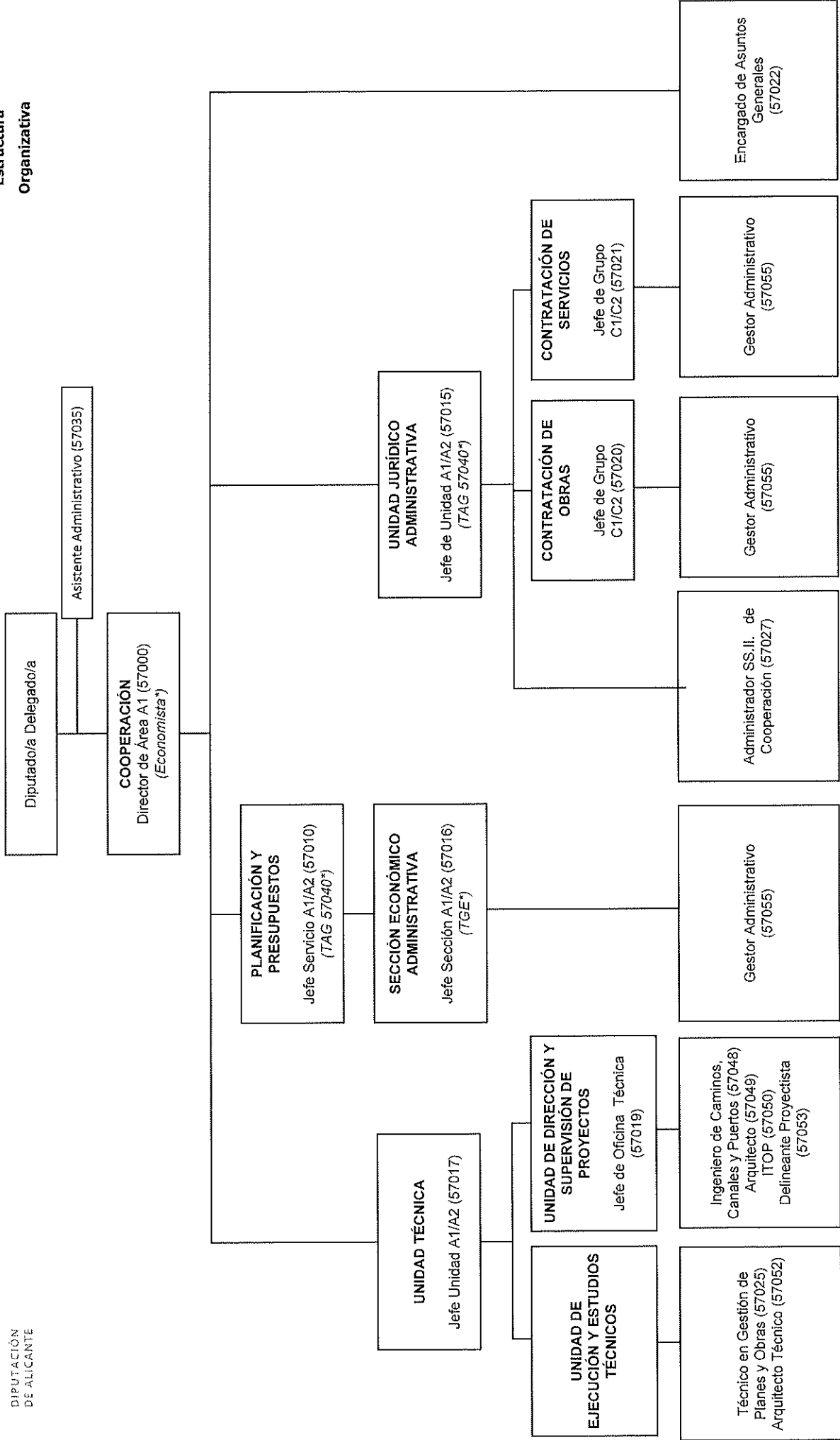

FOMENTO Y DESARROLLO

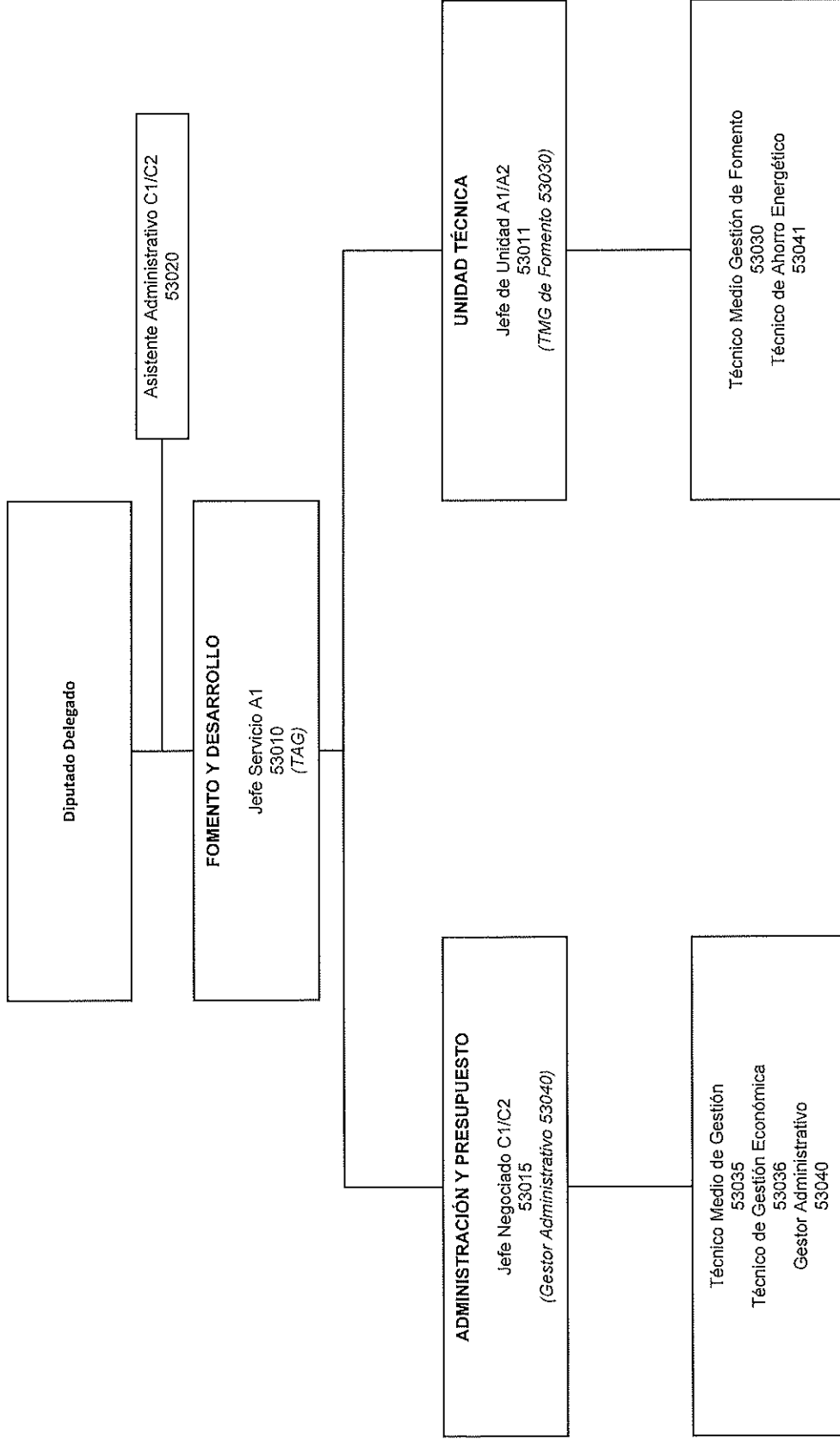



ÁREA DE MEDIO AMBIENTE, ENERGÍA Y RESIDUOS SÓLIDOS

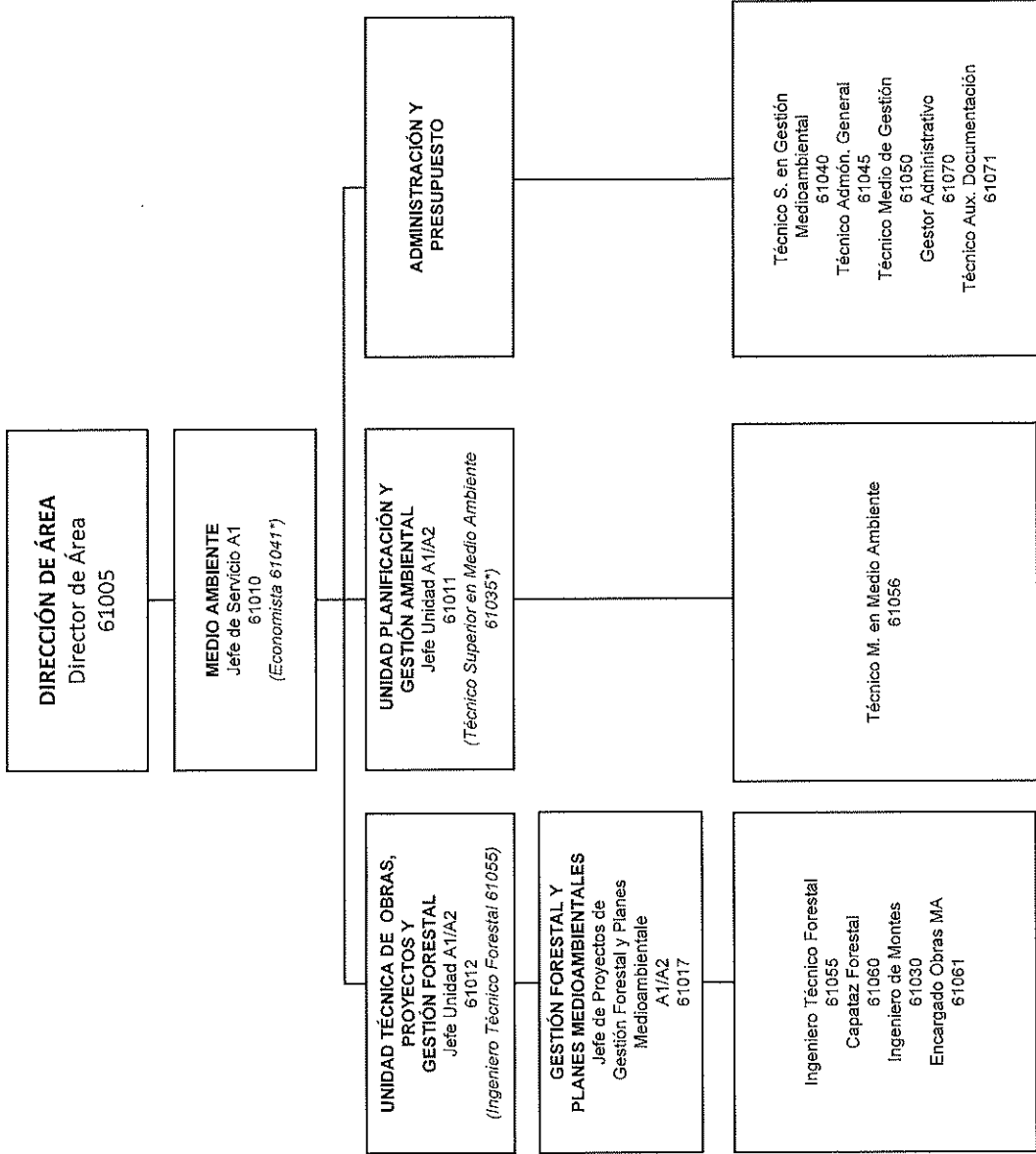



CICLO HÍDRICO

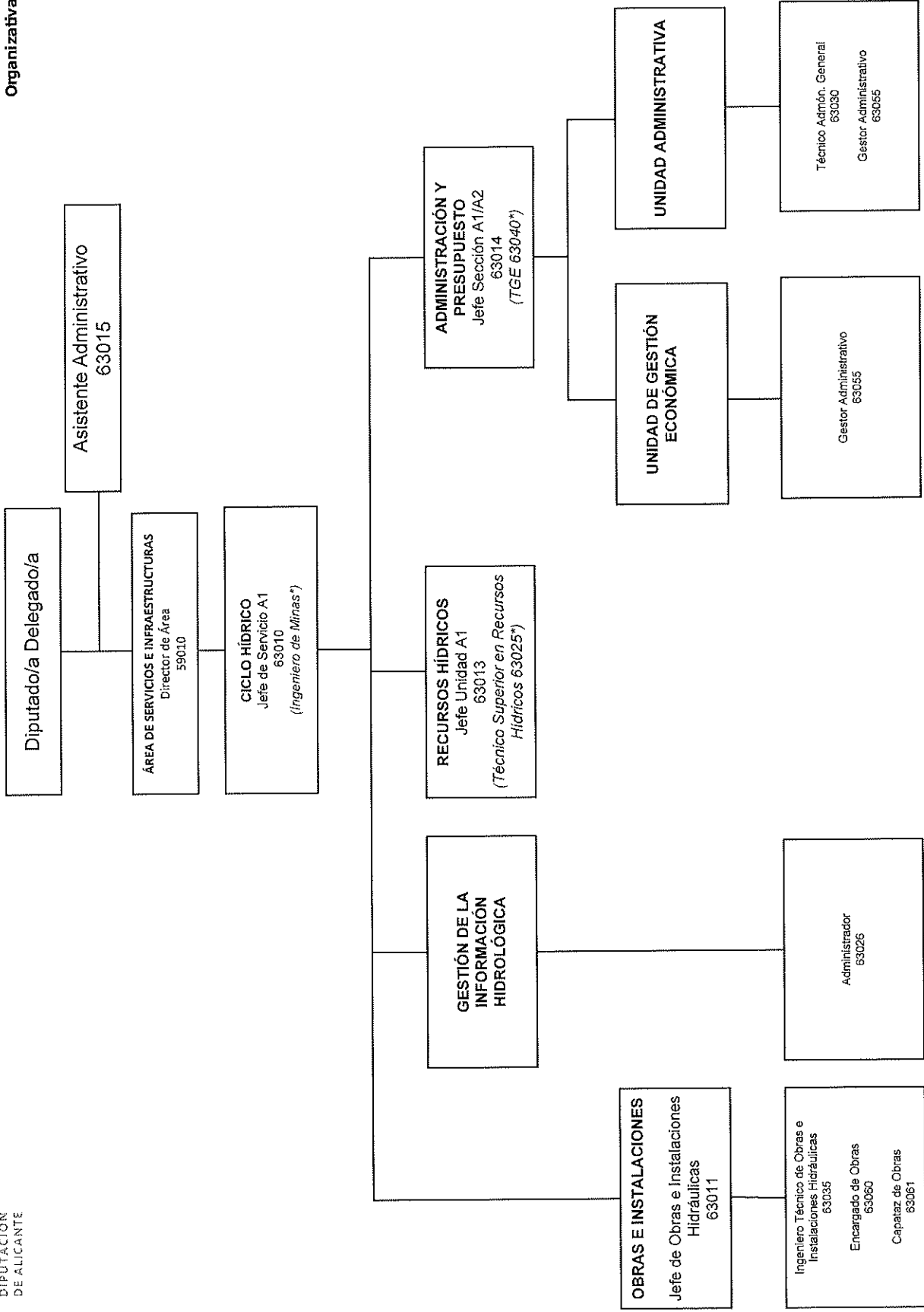

DR. ESQUERDO
- Área de Salud Mental -

Organigrama de Estructura Organizativa

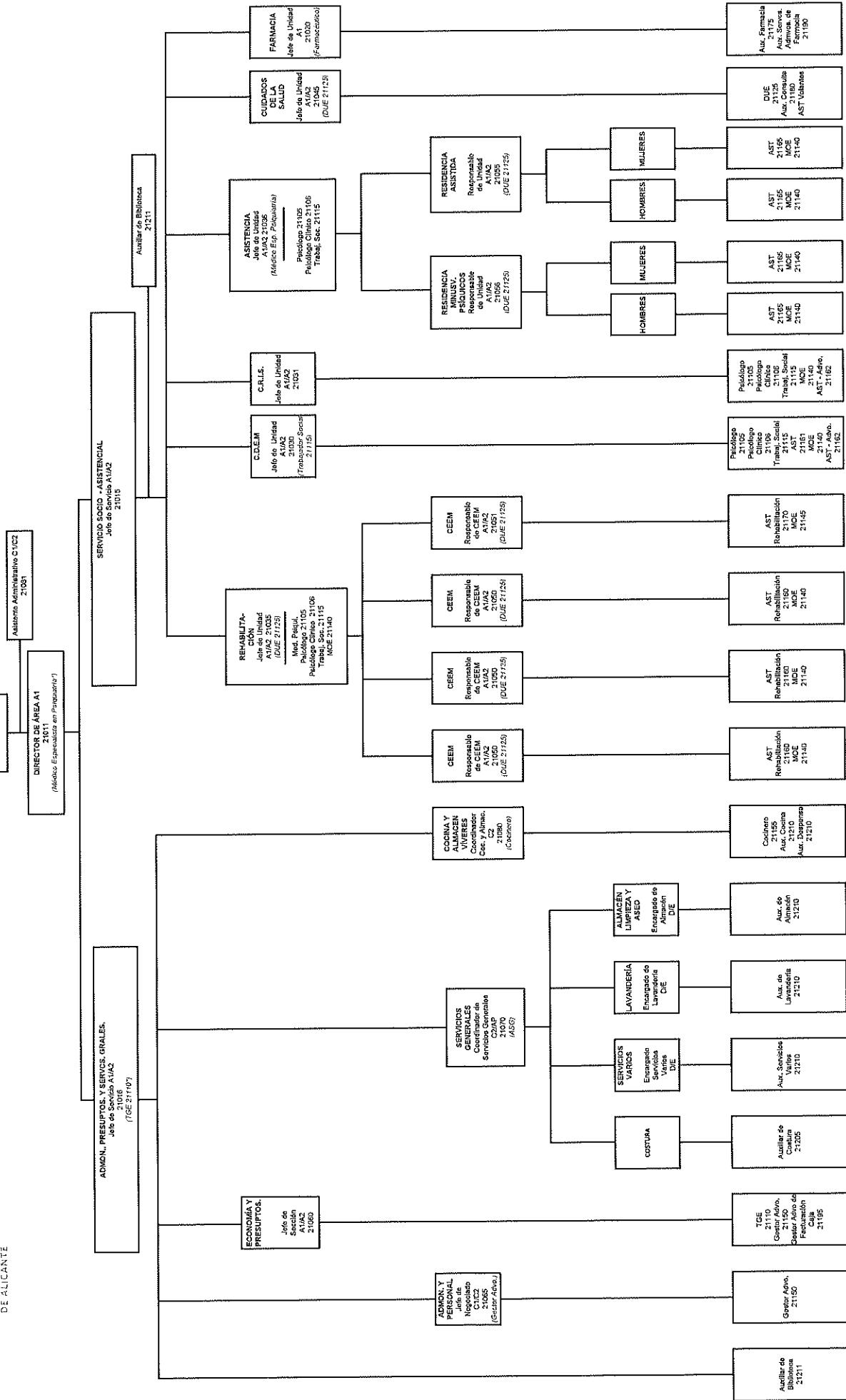



SERVICIO DE ASISTENCIA A MUNICIPIOS

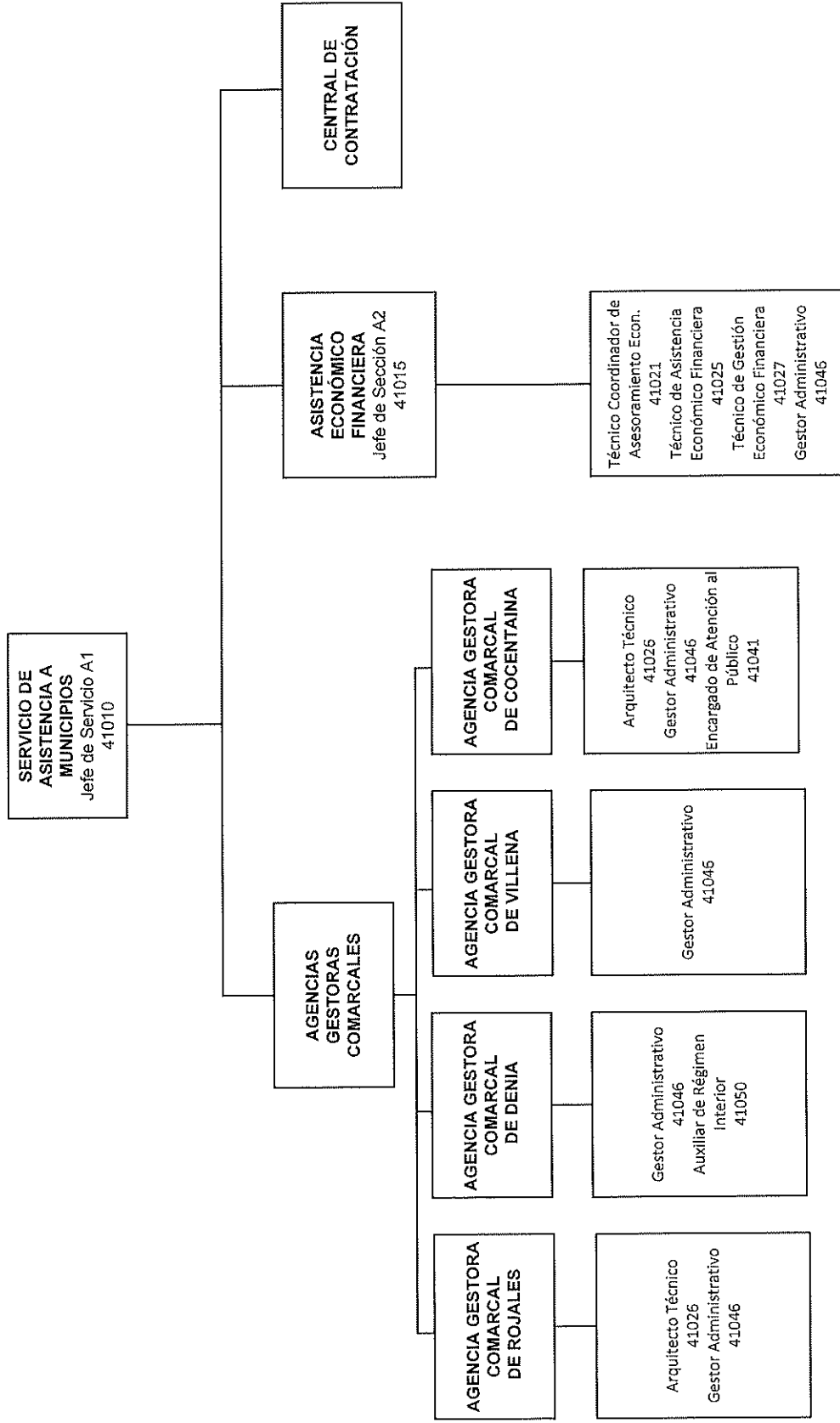

ARQUITECTURA

- Área de Arquitectura -

Organigrama de Estructura Organizativa

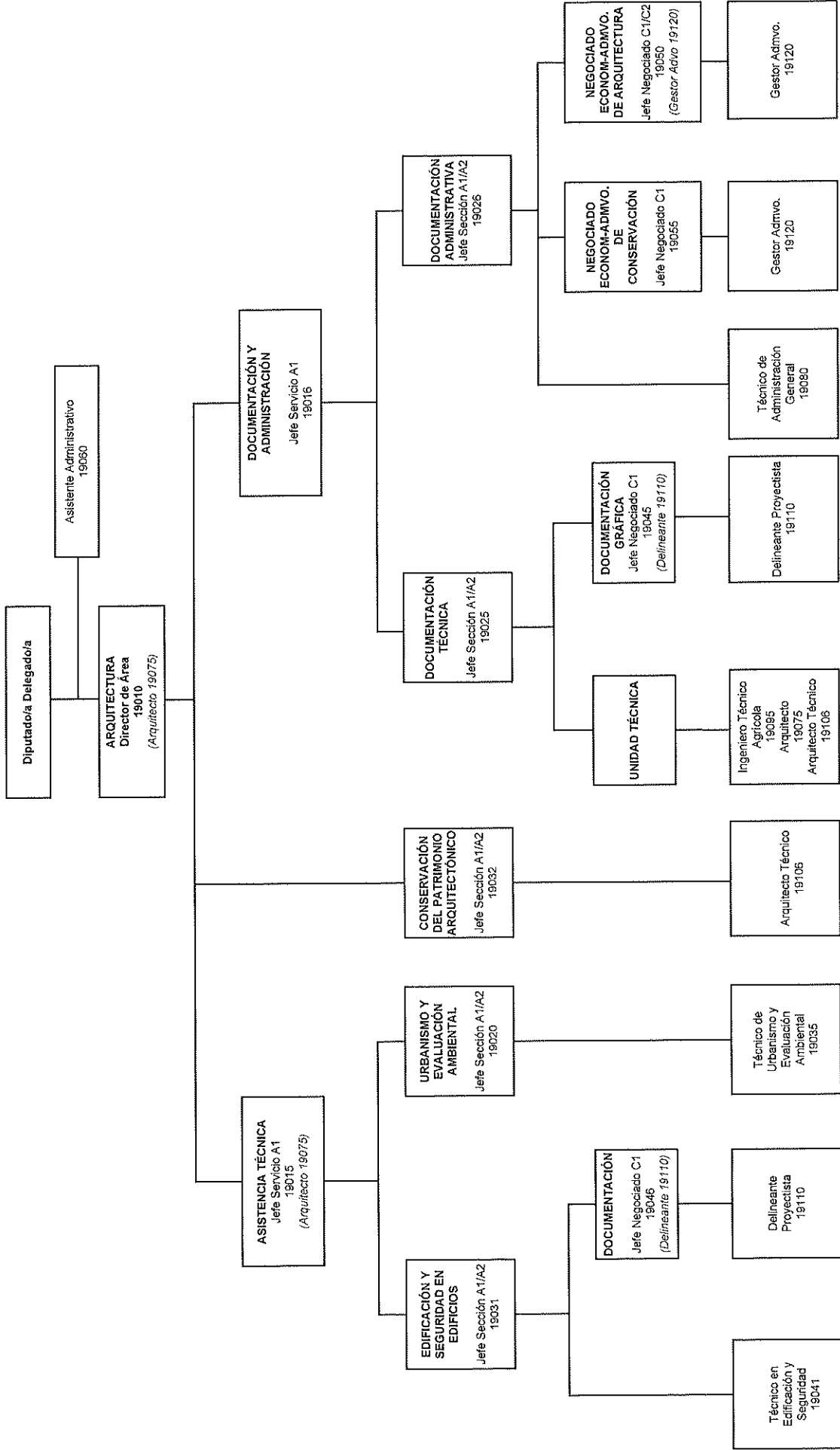

CARRETERAS

Organigrama de Estructura Organizativa

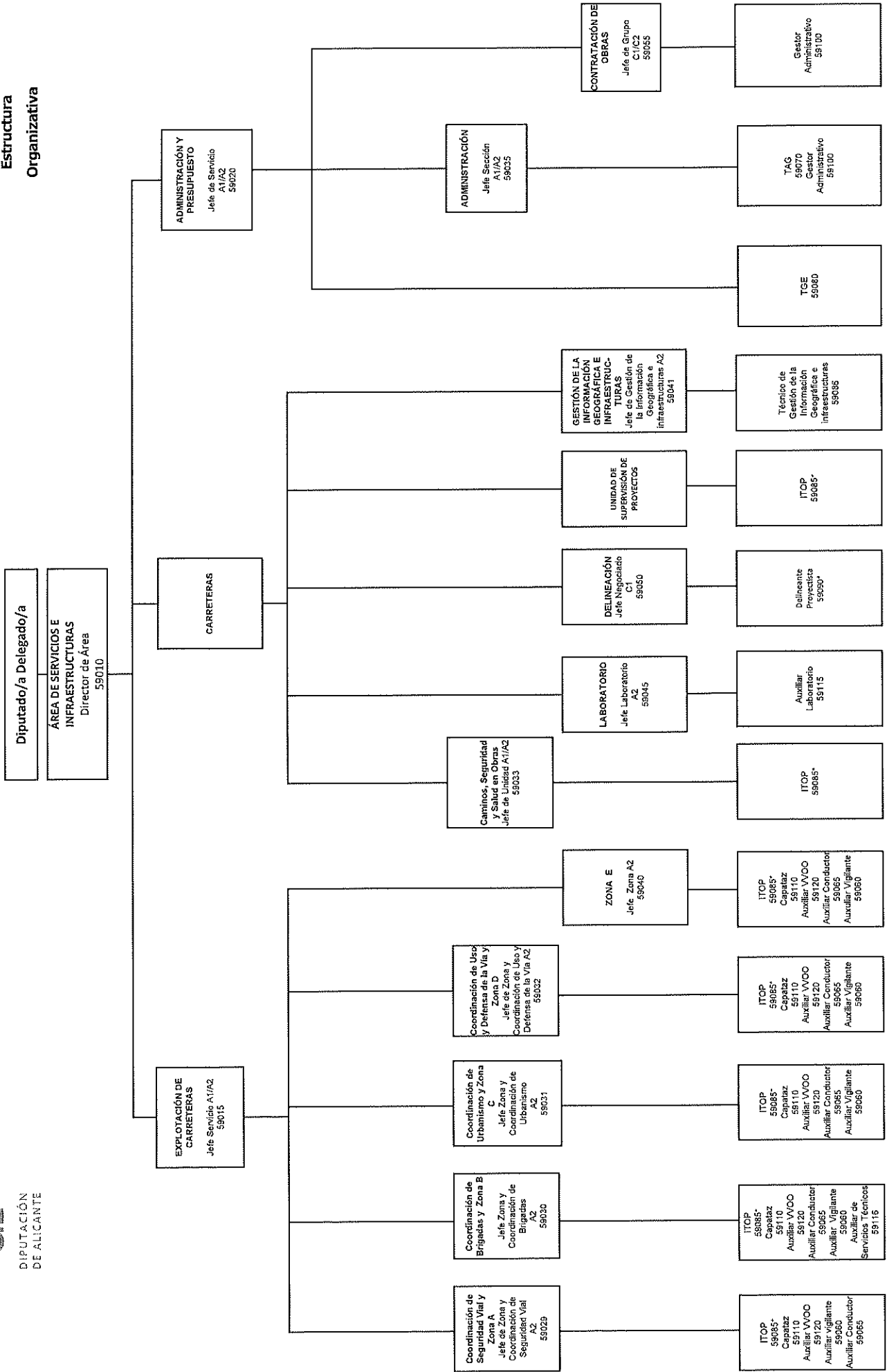

MUSEO ARQUEOLÓGICO PROVINCIAL

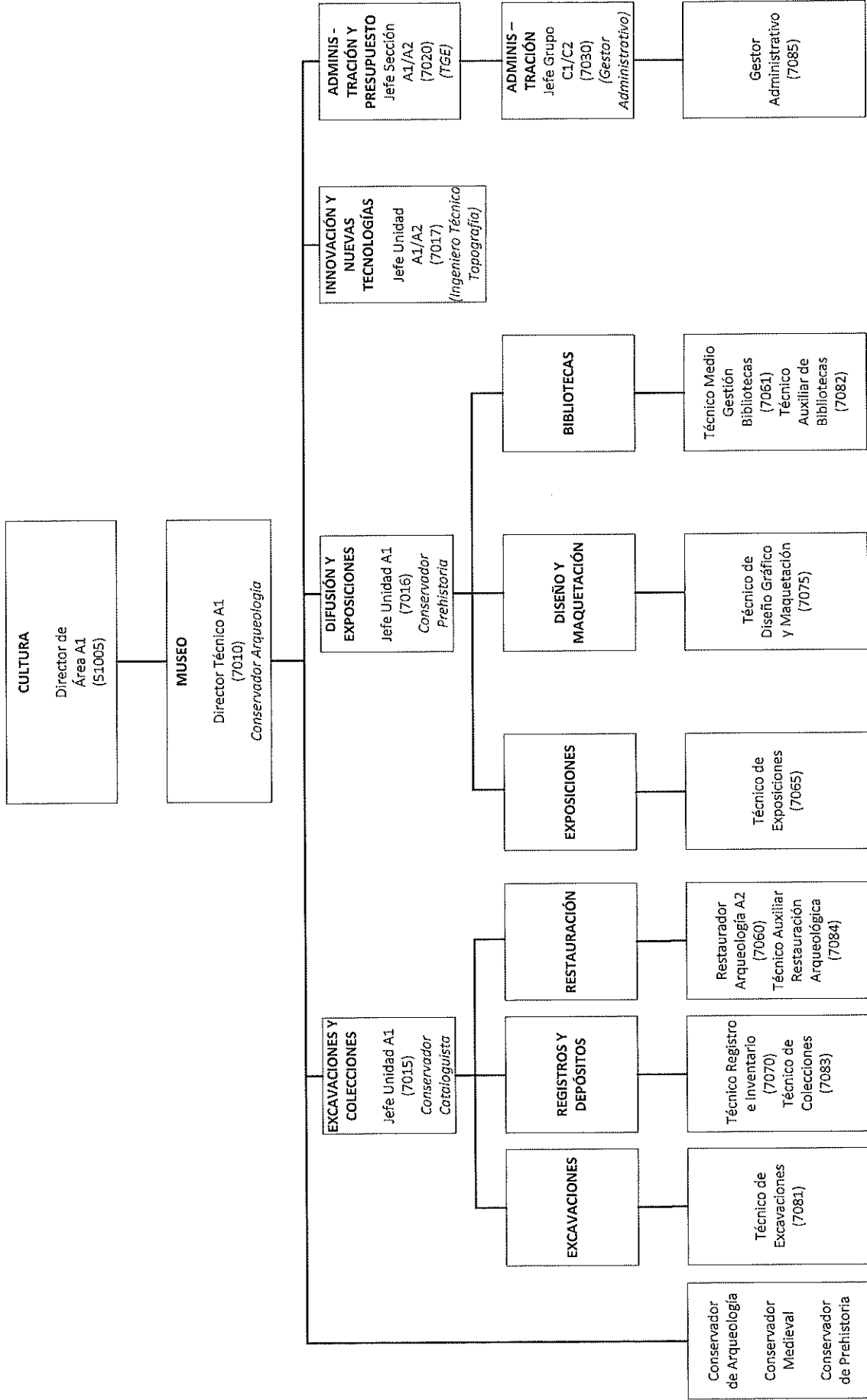

ATENCIÓN A CIUDADANOS EXTRANJEROS

Organigrama de
Estructura
Organizativa





RESIDUOS SÓLIDOS URBANOS

